

www.iranfluidpower.com
BTPHydraulics
hydraulic facts

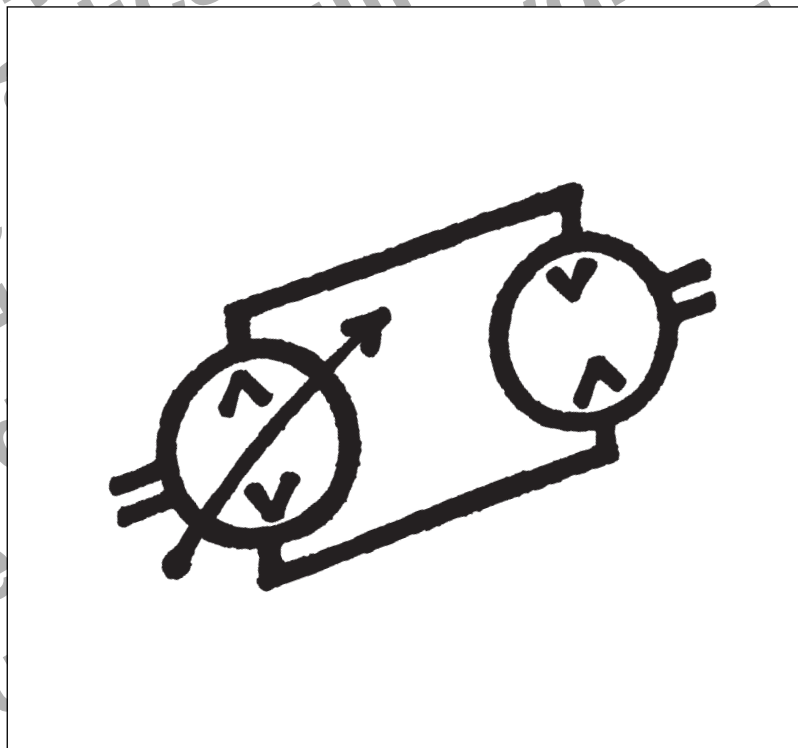

Contents

	Page
1. Introduction.....	3
2. Sizing.....	4
3. Selection of components.....	9
4. Selection of oil type.....	13
5. Checking the oil.....	18
6. Installation of system.....	18
7. Starting up and running in of plant	21
8. Maintenance.....	23
9. Fault location.....	24
10. Repair and testing	34
11. Symbols and tables	35
12. ISO/CETOP-symbols	36
13. Overview of Danfoss SERVICE SHOPS.....	40

Introduction

Like so many other technical fields, hydraulics is both old and new at the same time.

Take waterwheels for example, people have been using them since before history was recorded. On the other hand, the use of liquid under pressure to transfer force and also to control complicated movements is relatively new and has undergone its most rapid development within the last 40-50 years, not least because of the work that has been done in aeronautics.

Hydraulics and pneumatics are universal for the entire engineering industry and are amongst the three most important media for the transference and control of force. The two other media are mechanical transference (for example via clutch pedals and gears) and electrical (for example via a generator). "Flowing energy" is transferred and controlled through a medium under pressure - either air (pneumatic) or liquid (hydraulic).

This form of energy has many exceptional advantages and is therefore often the most suitable form of energy transference on land, sea or in the air.

A contained liquid is one of the most versatile means of controlling and transferring force. It takes the precise form of the walls that contain it and withstands its pressure. It can be divided into several streams which, depending on their size, can perform work before being allowed to merge into one stream again to perform still more work. It can be made to work fast in one part of a system and slowly in another.

No other medium combines the same degree of reliability, accuracy and flexibility while retaining the capability of transferring maximum force with minimum volume and weight. The quality control with this medium can be compared with the accuracy of an electronic micro-processor.

However, to achieve maximum utilization with highest efficiency and least possible operational stops, it is very important that a hydraulic system be designed, manufactured, started and maintained absolutely correctly. The special factors vital to the user (purchaser) must also be understood if operation in the field is not to be plagued by break downs and other disturbances.

Nearly all factory systems use "flowing energy" in production. More than half of all manufactured products are based on this form of energy, and it is therefore of interest to all manufacturers, exporters, purchasers, distributors, and repairers of production systems and machines, including agricultural machines and machine tools, the village smithy and the automobile industry, shipping and aviation.

Clearly, the knowledge and experience of many designers, producers, repairers and owners (users) is being outstripped by the dramatic development and rapid spread of hydraulics.

The purpose of this article is therefore not to try to provide patent solutions to all hydraulic problems, but to help create an understanding of why problems arise and what steps can be taken to avoid them.

Sizing

Reliable sizing provides the most optimal selection of components.

It is obvious that if undersize components are used, they will not operate under overload. They will be sensitive and become a frequent source of problems and complaints. More important still, in comparison with a correctly sized component an oversize component will probably operate problem-free and "effortlessly" for a very long time, but its original price will be too high.

If not able to carry out accurate calculations to obtain optimum conditions, the guidelines below are worth following.

The first thing to establish is the max. operating pressure required for the system since this is the decisive factor in pump selection and, in turn, important as far as the size (output) of the prime

mover and the system price are concerned. The higher the operation pressure, the higher the price of many of the components.

When the economic considerations have been made, particular types and sizes of operating cylinders, motors, and steering units to be used in the system can be considered.

The pump size is found by adding the necessary amounts of oil (expressed in gallon (litres) per minute) that can be in use at the same time.

Consequently, the total is the amount the pump must be able to supply at the maximum intermittent operating pressure (= pressure relief valve setting pressure).

Size of pump

The power applied to the pump must be found as a function of the pressure in psi (bar), revolutions per minute and flow in gal (litres) per minute, expressed in Hp (kW). The result can be used to find the size of motor that will safely yield the necessary output. See the following example.

Hydraulic output $N = \text{pressure} \times \text{flow}$, i.e.
 $N = p \times Q$

Example:

$$N = \frac{p \times Q}{400} \quad [\text{Hp}]$$

$p = 2175 \text{ psi}$

$$Q = 11.9 \text{ gal/min} \quad N = \frac{2175 \times 11.9}{400} = 64.71 \text{ Hp}$$

When calculating the necessary pump output (P_{neec}), account must be taken of the total pump efficiency, (η_{tot}) as stated in the catalogue.

Example:

$$P_{\text{an}} = \frac{p \times Q}{400 \times \eta_t} = \frac{2175 \times 11.9}{400 \times 0.9} = 71.9 \text{ Hp}$$

$$V = \frac{Q \times 1000}{n \times \eta_{\text{vol}}} \text{ cm}^3/\text{min}^{-1}$$

Sizes of pipes and hoses

The size depends on:

- max. system pressure
- max. oil flow
- length of pipe system
- environmental conditions

Pressure drop must be as small as possible. The greater the resistance in the system, the greater the operational loss. It is important to avoid those factors which cause pressure drop, for example the use of angled screwed connections. Where possible, these should be replaced by elbows. If long lengths of pipe or high flow velocity are involved, then an increase in diameter up to the next size should be considered.

Remember that the dimensions stated for the hydraulic pipes are the external diameters and wall thicknesses. The internal diameters are equal to the external diameters minus 2 x the wall thickness.

Remember that when the internal diameter is doubled, the flow area of the pipe is quadrupled.

Now the oil capacity supplied per minute by the pump is known, along with the amount of oil the individual components must have. The next stage is the dimensioning of pipes and hoses. This is also very important as otherwise, generated cavitation (noise), heat generation, pressure drop and, in some cases, bursting can occur.

There are many people who are frightened of this dimensioning as they associate it, incorrectly, with difficult mathematical calculations. In actual fact, if the nomogram adjacent is followed when calculating pipe dimensions, it is incredibly simple.

In order to use the nomogram, the first thing is to know the oil flow in gallons (liters) per minute. After this it has to be known whether the pipes and hoses in question are to be used as suction lines, pressure lines or return lines. This is because there are some recommended velocities of oil flow available for these categories. These values are as follows:

- Suction line 1.6 - 4.9 ft/s
- Pressure line 9.8 - 32.8 ft/s
- Return line 6.6 - 16.4 ft/s

Sizing

Using the nomogram

Place a ruler over the two outer columns, i.e. the known oil flow and the required speed (velocity) for the pipe type in question. Read off the nearest internal pipe diameter on the middle column. (See example page 7).

Depending on the maximum pressure a decision can also be made as to whether to use light or heavy hydraulic pipes and hoses. Here a large price difference is involved, especially with the associated fittings. See table of pipe dimensions and max. working pressure.

Valves

Valves are used in all hydraulic systems. In simple systems maybe only a pressure relief valve (safety valve) and a single directional valve are used. Other systems might be more complicated and might involve a large number and wide variety of electronically controlled proportional valves.

It is probably within valves that the choice of components is widest and where it is easy to use and waste most money if wrong

selections are made.

If in doubt, the suppliers of recognized valve brands can be approached for advice on the selection. It is important not to select a valve which is too small or too large in relation to flow. If it is too small, the relative pressure drop will be too high, resulting in heat generation and possibly cavitation. If the valve is too large it can result in poor regulating characteristics where the cylinder will pulsate, or the system will oscillate.

Calculating on tube diameter

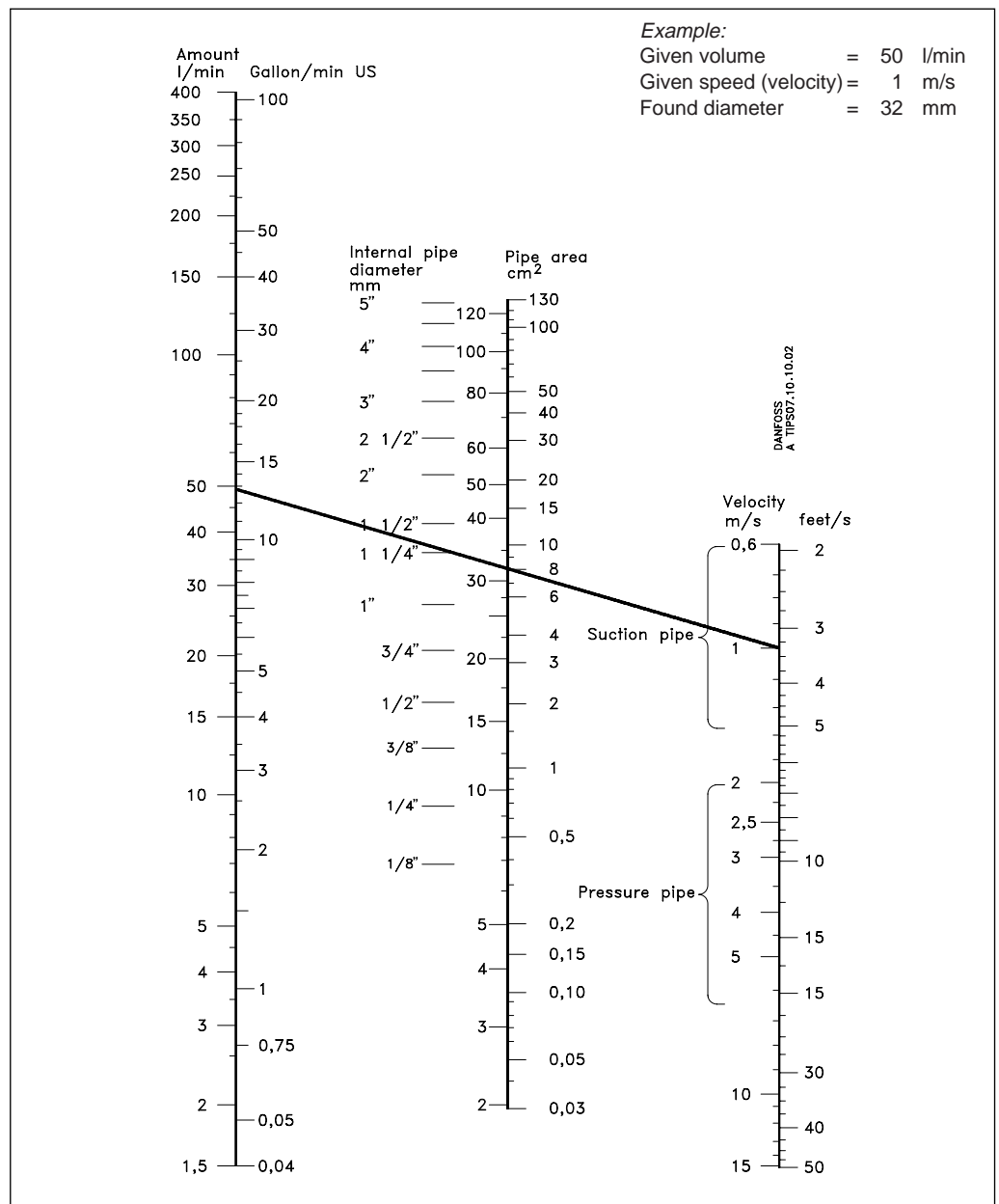

Sizing

Calculation of piston velocity - oil flow

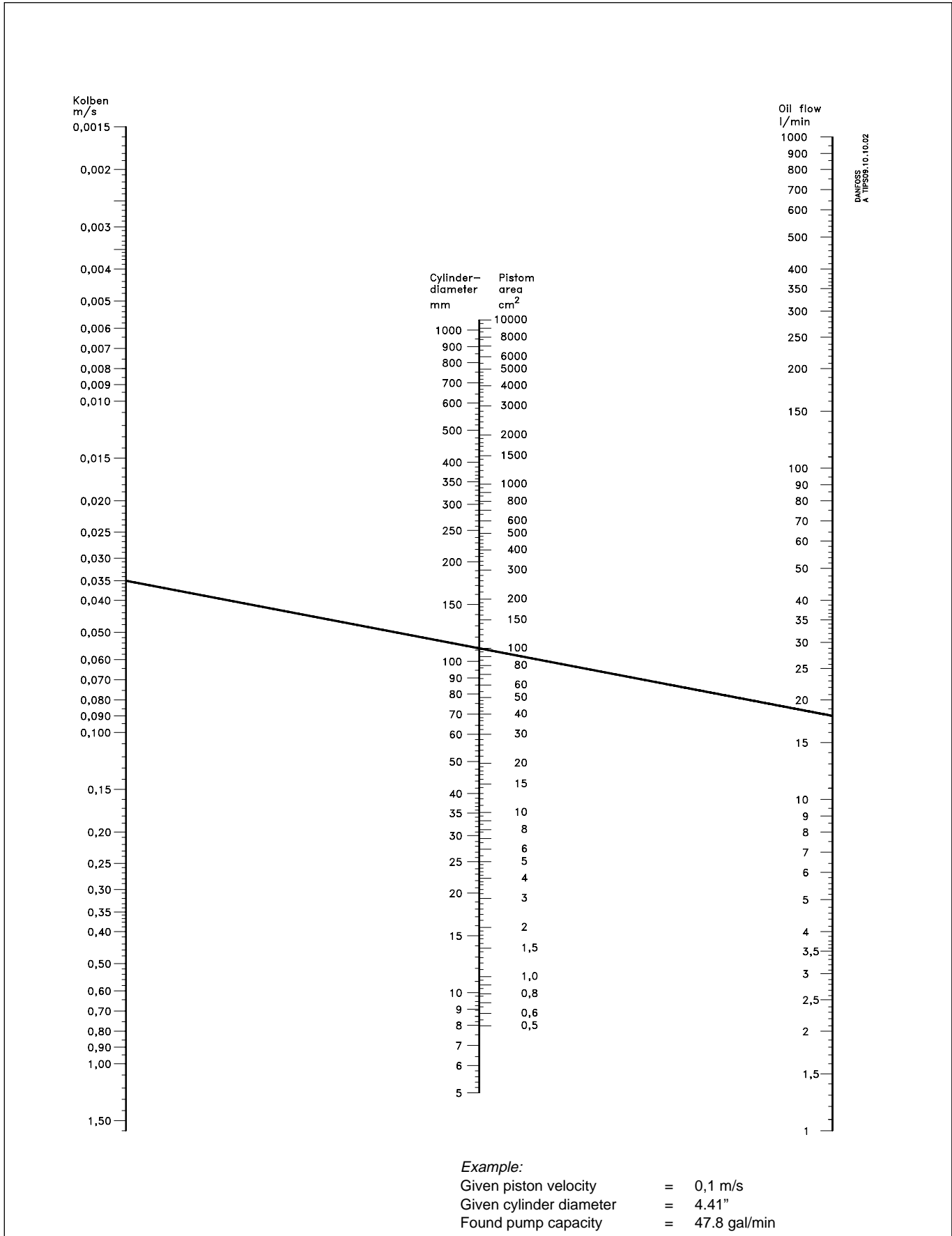

Calculation of cylinder force

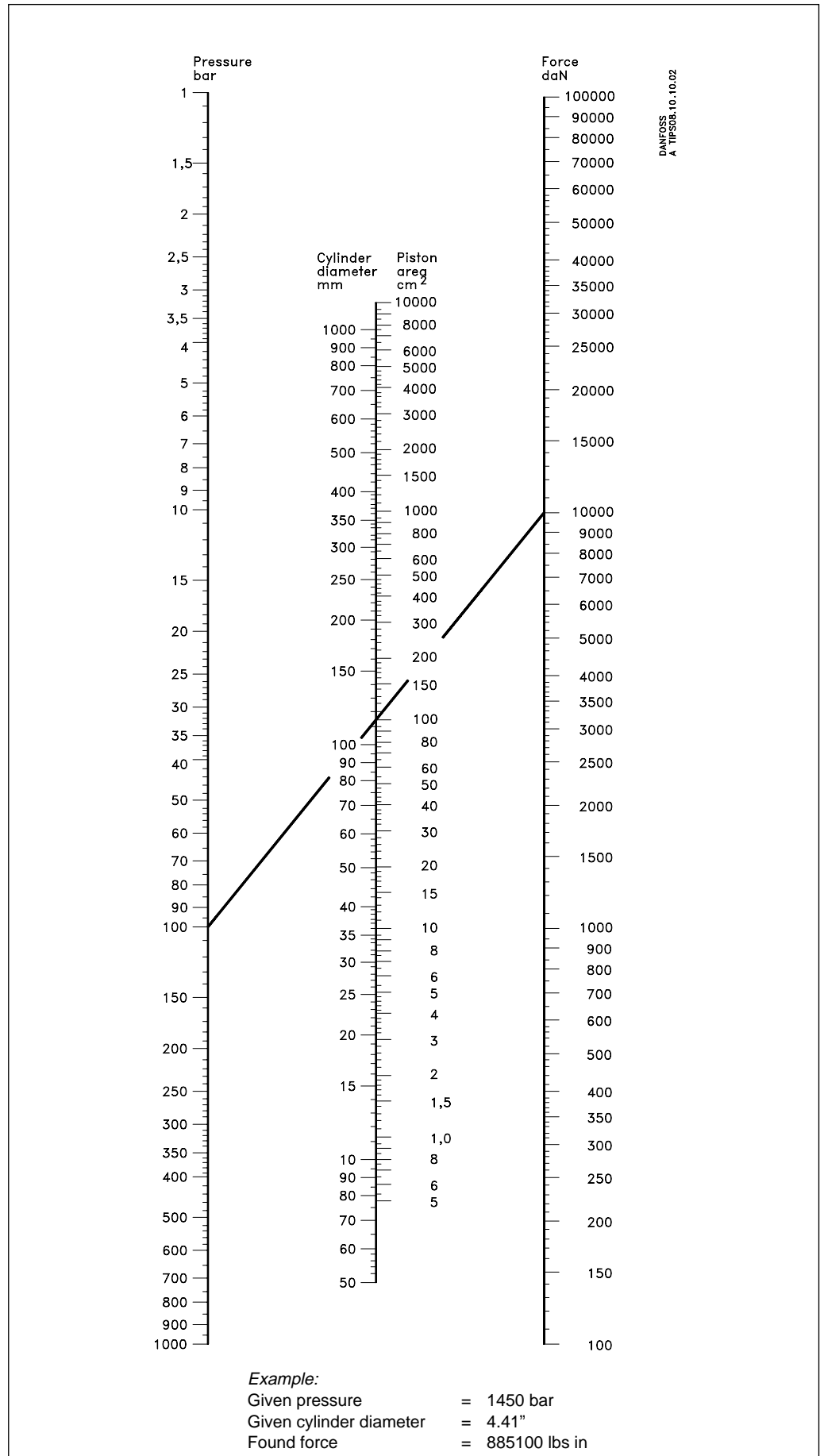

Selection of components

All hydraulic systems consist in principle of the same basic components, but just as with electronics, the combinations are infinite and the range of components immense. Which components are the most important in a system?

-is it the cylinder or the motor that is going to perform the work,
-or the liquid (oil) that transfers force to the motor or cylinder,
- ... or the pipes and hoses that lead oil to motor and cylinder,
-or the valves that control the oil flow paths,
-or the pump that applies energy and movement to the oil,
-or the motor that drives the pump,
-or the filter that removes dirt from the oil,
-or the oil cooler that ensures a suitable oil temperature,
-or the tank that contains oil for the system..

The answer must be that specific demands are made on all these components and since none of them can be allowed to fail, they must all be equally important. Therefore extreme care must be taken in all stages of their creation, selection and application.

When a hydraulic diagram is being prepared,

the designer must have quality in mind, including the quality of the drawing itself, so that any errors in interpreting the drawing are avoided. It is a good idea always to use the correct ISO/CETOP-symbols.

When the diagram is subsequently used in preparing parts lists and accurate component specifications, sizing problems often occur. The designer is confronted with brightly coloured brochures and catalogues and, at first, all is confusion. The temptation is to revert to rule-of-thumb methods and "add a bit for safety's sake", the result being a system which is either over or under designed.

All reputable hydraulic component manufacturers give real, usable values in their catalogues, not just theoretical desired values. The technical data in Danfoss catalogues always represents average values measured from a certain number of standard components. In addition to these data, the catalogues contain a mass of useful and explanatory information on selection, installation and start up of components, together with a description of their functions. This information must, of course, be used as intended in order to avoid overload, too high a wear rate, and consequent oil overheating and to avoid an over-dimensioned system with poor regulation at too high a price.

The tank

Let us look a little closer at an example system, starting with:

The tank, which has many functions e.g.

- as a reservoir for the system oil
- as a cooler
- as a "coarse strainer", sedimentation of impurities
- as an air and water separator
- as a foundation for pumps etc.

The dimensions of the tank and its form are important and it should therefore be designed for its purpose, the same as all other hydraulic

components. Its location must also be taken into account so that the sight glass, filters, filling cap, air filter, drain cock, etc. are easily accessible for daily inspection. If the application is mobile, if there is no cooler built into the system, and provided the tank is located where air circulation is good, the size of the tank can be fixed at approx. 3-4 times the capacity of the pump per minute.

Two arrangements are shown below. Arrangement 1 is preferred as this increases the cooling effect as much as possible.

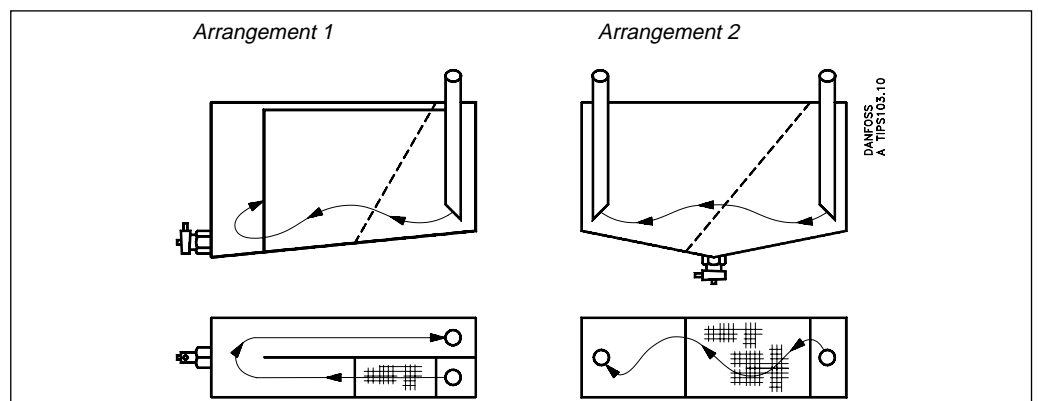

Selection of components

To increase the ability of the tank to separate dirt and water, the bottom must be slightly inclined (deepest end opposite the inlet/outlet end). An ordinary cock (without handle) is fitted so that impurities can easily be drained off. Increased separation of the air that is always present in the oil can be obtained by fitting an inclined coarse metal strainer (approx. 25-50 mesh/ inch) by the return line.

Both suction and return pipes must be cut diagonally. The ends of the pipes must be located 2-4 times the pipe diameter above the bottom of the tank, partly to avoid foaming at the return line, and partly to prevent air from being drawn into the suction line, especially when the vehicle/vessel heels over to one side. With regard to the annual "spring-clean", the tank must have large removable covers, either in the sides, in the top, or in the ends, in order to give easy access for cleaning. If filters are installed, they must be located above the tank oil level and must be easy to replace without significant spillage. That is to say, it must be possible to place a drip tray under the filter inserts.

Since tanks are made of steel plate, rust is inevitable (even below the oil level, because oil contains both water and oxygen) and it is therefore advisable to surface-treat the inside. If the tank is to be painted, thorough cleaning and degreasing is necessary before primer and top coats are applied. The paint used must, of course, be resistant to hot hydraulic oil.

If the cooling effect from the tank and other hydraulic components is insufficient in order to keep oil temperature down to an acceptable maximum an oil cooler must be fitted. Most suppliers prescribe 194 °F (90°C) as an absolute maximum partly because of lifetime of rubber parts, partly because of alterations of tolerances and possibly bad lubrication. Today quite often electronic devices are fitted directly onto the hot hydraulic components. In consideration of the electronics, a reduction of the max. oil temperature to under 176 °F (80°C) must be aimed at.

Filters

The degree of filtering and filter size are based on many different criteria that generalisation is seldom possible. The most important factors to be considered are as follows:

Operational environment:

How serious would the consequences be if the system failed because of dirt?

Oil quantity:

Would there be a few litres or several hundred litres in the system? Is it an expensive or a cheap oil?

Operational down time:

What would it cost per hour/day if the system shut down? How important is this factor?

Dirt sensitivity:

How dirt-sensitive are the components? What degree of filtering is recommended by the component manufacturers?

Filter types:

Are suction filters, pressure filters or return filters to be used, or a combination of these with or without magnets? Is exclusive full-flow filtering involved, or will there also be by-pass filtering through fine filters? Which type of dirt indicators are to be used, visual, mechanical or electrical?

Air filtration:

Air must be filtered to the same degree as the finest filter in the system, otherwise too much dirt can enter the tank with the air. If there is a large differential or plunger cylinders are in the system, the tank breathes in/pushes out large amounts of air, therefore the size of the air filter must be on the large side. Remember that dirt particles visible to the naked eye (larger than 40 µm) are as a rule, less dangerous than those that cannot be seen. It is often the hard particles of 5 - 25 µm, corresponding to normal hydraulic component tolerances, that are the most dangerous.

Relative size of particles

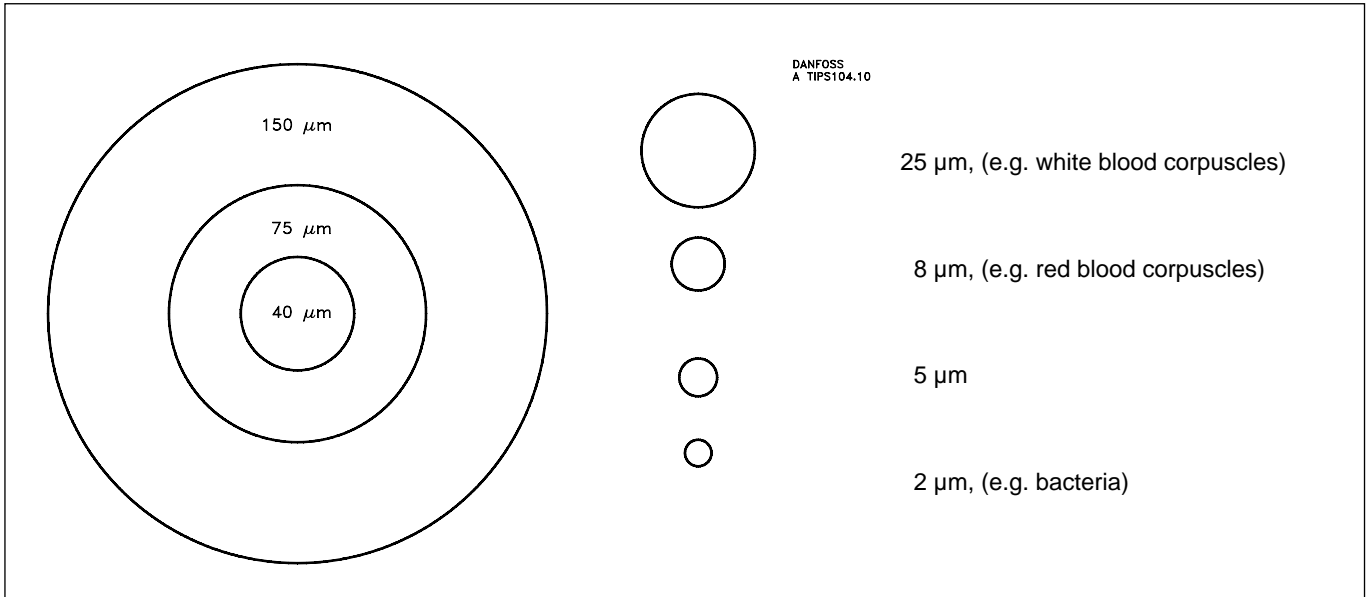

The naked eye is unable to see objects smaller than 40 μm .

For normal operation, the degree of filtration for hydraulic products can generally be divided into the categories below:

Motors:
25 μm nominal - degree of contamination 20/16 (see ISO 4406) for return filter, or combined with a magnetic insert if a coarser filter is used, e.g. 40 μm .

Steering units:
For systems having an efficient air filter and operating in clean surroundings, 25 μm nominal is adequate. If this is not the case 10 μm absolute - to 19/16 must be fitted. Filters can be either pressure or return filters.

Proportional valves:
System filters
Where demands for safety and reliability are very high a pressure filter with bypass and indicator is recommended. Experience shows that a 10 μm nominal filter (or finer) or a 20 μm absolute filter (or finer) is suitable. It is our experience that a return filter is adequate in a purely mechanically operated valve system.

The fineness of a pressure filter must be selected as described by the filter manufacturer so that a particle level 19/16 is not exceeded.

Radial piston pumps:
In open as well as closed systems:

Suction filter:
100 μm nominal or finer, but not finer than 40 μm nominal.

Return filter:
20 μm absolute or 10 μm nominal - 19/16.

Filters should be fitted with a dirt indicator so that operating conditions can be observed. This is especially important with suction line filters to avoid pressure drop in the suction line and consequent cavitation. The pressure in the suction line must not be less than 11.6 psi (0.8 bar) absolute.

Remember that drain lines from valves, motors etc. must also be led through the return filter to the tank. For pumps the drain oil pressure must not exceed 14.5 psi (1 bar). Therefore the drain oil should bypass the filters.

Selection of components

Dimensions

Remember that drain lines from valves, motors etc. must also be routed through the return filter to the tank. For pumps, the drain oil pressure must not exceed 14.5 psi (1 bar), therefore the drain oil should bypass the fil-

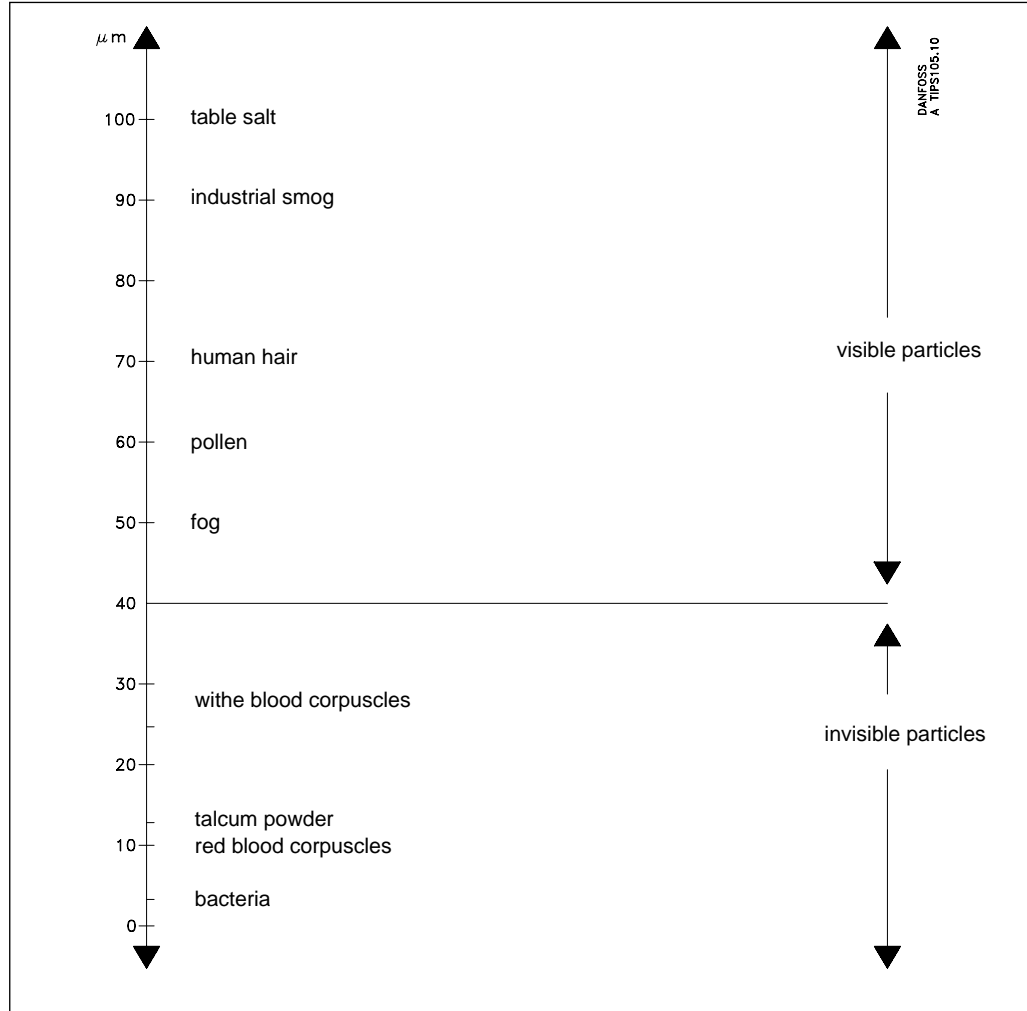

Selection of oil type

Oil requirements

The oil in a hydraulic system must first and foremost transfer energy, but the moving parts in components must also be lubricated to reduce friction and consequent heat generation. Additionally, the oil must lead dirt particles and friction heat away from the system and protect against corrosion.

- good lubricating properties
- good wear properties
- suitable viscosity
- good corrosion inhibitor
- good anti-aeration properties
- reliable air separation
- good water separation

Types of hydraulic fluids

- Mineral oil
- Water
- Oil/water-emulsions
- Water/polyglycol mixture
- Synthetic liquids

Oil types

The most common hydraulic oil is a mineral based oil. CETOP RP75H-class is comprised of the following 4 groups:

- HH: oil without additives - HL: oil with special additives for improving fluid life-durability and protecting against corrosion - HM: "HL" + additives for improving wear-properties - HV: "HM" + additives for improving the viscosity index

However, it can be an advantage to use other types of oils, especially in mobile systems such as tractors, etc. There is an advantage to be gained here from the use of the same oil for the diesel motor, the gearbox and the hydraulic system which often supply oil to both the working hydraulics and the steering. Other systems use transmission oil for the gearbox and hydraulics. In mines and off-shore installations, fire retarding liquids are used.

Non-inflammable fluids

Fire retarding hydraulic oils are sometimes classified as "non-inflammable hydraulic oils", but they will all burn under unfavourable conditions.

In water-based hydraulic oils it is solely the water that makes them fire retarding. When the water has evaporated, they can burn. Among synthetic fire retarding hydraulic oils, only phosphate esters are used.

It is important to select an oil type containing the correct additives, i.e. those which match the problem-free operation and long operating life for both hydraulic components and the oil itself can be ensured by following the maintenance instructions.

Additives

To improve the characteristics of a mineral oil, different kinds of additives are used. Normally the desire is to improve the following characteristics:

- Lubrication with metal/metal contact at high and low speeds.
- Viscosity change must remain small in a wide temperature and pressure range. This characteristic is called the viscosity index (VI)
- Air solubility must be low and air emission high.
- Foaming tendency must be low.
- Rust protection must be high.
- The toxicity of the oil and its' vapour must be low.

The amount and type of these additives are seldom given by suppliers, for such precise data are hardly of significance. The exception however, is antiwear additives because these are important as far as avoiding seizing and prolonging the operating life of the system.

In the opinion of Danfoss, the ideal oil contains:

- either : 1.0-1.4% Dialkylzincdithiophosphate (tradename Lubrizol 677A)
- or : 1.0-1.6% tricresylphosphate (tradename Lindol oil)
- or : 1.0-1.6% Triarylphosphate (tradename Coalite)
- or : additives producing similar effects.

Selection of oil type

Motor oil

Motor oils and most transmission oils contain self-cleaning additives. These are a disadvantage in hydraulic systems. For example, water condensed from the oil

cannot be drained off; it forms an emulsion with the oil. This in turn leads to filters becoming clogged too quickly.

Viscosity classification system

The International Organisation for Standardisation (ISO) has developed a system viscosity classification system for industrial

lubricating oil which Shell and the other large oil companies have decided to introduce (ISO 3448)

Viscosity diagram

ISO Viscosity No.	Middle viscosity in cSt (mm ² /s) at 104°F 40°C	Kinematic Viscosity limits in cSt (mm ² /s) at 104°F (40°C)	
		Minimum	Maximum
ISO VG 2,00	2,20	1,98	2,42
ISO VG 3,00	3,20	2,88	3,52
ISO VG 5,00	4,60	4,14	5,06
ISO VG 7,00	6,80	6,12	7,48
ISO VG 10,00	10,00	9,00	11,00
ISO VG 15,00	15,00	13,50	16,50
ISO VG 22,00	22,00	19,80	24,20
ISO VG 32,00	32,00	28,80	35,20
ISO VG 46,00	46,00	41,40	50,60
ISO VG 68,00	68,00	61,20	74,80
ISO VG 100,00	100,00	90,00	110,00
ISO VG 150,00	150,00	135,00	165,00
ISO VG 220,00	220,00	198,00	242,00
ISO VG 320,00	320,00	288,00	352,00
ISO VG 460,00	460,00	414,00	506,00
ISO VG 680,00	680,00	612,00	748,00
ISO VG 1000,00	1000,00	900,00	1100,00
ISO VG 1500,00	1500,00	1350,00	1650,00

Checking the oil

Water in the oil

There is evidence that more than 70% of all problems with hydraulic systems can be traced directly to the condition of the oil. If there is water in the oil, the oil must be replaced as this not only damages the ball and roller bearings but also causes corrosion of all steel surfaces. This especially applies to those surfaces touched by the oil, for in addition to

water, oxygen is present and this promotes rust. A further danger is the reduction of the operative area of filters and the consequent increase in the abrasiveness of the oil.

Oil oxidation

Normally an oil operating temperature of 86°F-140°F (30-60°C) ought to be aimed at since the life of hydraulic oil is strongly dependent on its operating temperature. The rule-of-thumb is that the useful life of an oil is halved for every 46.4°F (8°C) the temperature rises above 140°F (60°C). That is to say, at 194°F (90°C) the life of the oil is only about 10% of its life at 140°F (60°C).

The reason for this is oxidation. At atmospheric pressure, all oils contain a little less than 0.03 gal (0.1 litres) of air per 0.264 gal (litre) of oil. Therefore, in practice, oxygen is always present and it reacts with the hydrocarbons making up the oil. Gradually, as oxidation increases, the oil becomes darker in colour and its' viscosity rises.

Finally, the products of oxidation can no longer be dissolved in the oil, but instead settle everywhere in the system as a brown sticky layer. This will cause sticking valves and high friction in ball bearings, valve spools and pump pistons. Oxidation also produces corrosive acids.

The oxidation process begins gradually, but at a certain stage the oxidation rate suddenly rises and the viscosity rises. The resulting increase in operating temperature accelerates the oxidation process even more and soon the oil becomes quite unusable as a hydraulic oil because of deposits, high viscosity and accumulated acids. It therefore pays to take care of the oil. Even without proper laboratory equipment, many factors can be checked.

The presence of water

It is possible to make the following checks:

The presence of water can be detected as follows. Drain 32.8 or 49.2 in³ (cm³) of oil into a test tube and allow it to stand for a few minutes until any air bubbles have disappeared. Then heat up the oil, with a gas lighter, for

example, and at the same time listen (at the top of the test tube) for small "explosions" in the oil. This sound comes from the creation of water vapour when the small water particles in the oil are shock-boiled.

Viscosity

Viscosity can be established with sufficient accuracy using homemade equipment consisting of a small container (e.g. a can) which is able to hold 0.2 gal ($\frac{3}{4}$ liters) of liquid. The bottom of the can must be pushed slightly outwards and a burr-free hole of 0.16"-0.2" (4-5 mm) drilled. Pour water which has been heated to 104°F-122°F (40 - 50°C) into the can whilst keeping a finger over the hole. Remove the finger and record in seconds how long it takes for the water to run out. Repeat the process, but this time use oil. The viscosity of the oil can be calculated in degrees Engler (E°).

Engler Viscosity =

$$\frac{\text{drain time for oil}}{\text{drain time for water}} = E^\circ$$

See conversion table page 20.

Checking the oil

The smell and appearance The smell and appearance of an oil sample also reveals much about its condition, especially if it is compared with a sample of clean unused oil at the same temperature and in the same kind of glass container. By allowing two such samples to stand overnight, the bottom of the glass containing the used oil might reveal a deposit. If it does the oil in the system must be fine-filtered and the tank cleaned.

If these relatively crude tests indicate that the oil might be bad, small systems should scrap the oil. For larger systems an oil sample of approx. 1/2 - 1 liter should be sent to a laboratory for a thorough check. Remember it is important that the bottles used for the samples are completely clean.

Tables for converting viscosity

cSt	E°	R	S	cSt	E°	R	S
1,00	1,00	26,7	29,3	26,00	3,58	109,1	123,6
1,50	1,07	28,4	31,3	27,00	3,71	113,0	128,0
2,00	1,12	30,3	33,1	28,00	3,83	117,0	132,4
2,50	1,17	31,7	34,8	29,00	3,96	120,9	136,8
3,00	1,22	33,0	36,5	30,00	4,09	124,8	141,3
3,50	1,27	34,5	38,0	31,00	4,21	128,8	145,7
4,00	1,31	35,8	39,5	32,00	4,34	132,7	150,2
4,50	1,35	37,1	41,0	33,00	4,47	136,6	154,7
5,00	1,40	38,5	42,5	34,00	4,58	140,6	159,2
5,50	1,44	39,7	44,0	35,00	4,71	144,4	163,7
6,00	1,48	41,1	45,4	36,00	4,83	148,8	168,2
6,50	1,52	42,4	47,0	37,00	4,96	152,5	172,8
7,00	1,57	43,8	48,6	38,00	5,09	156,5	177,3
7,50	1,60	45,2	50,2	39,00	5,22	160,5	181,9
8,00	1,65	46,5	51,8	40,00	5,34	164,5	186,5
8,50	1,70	48,0	53,4	41,00	5,47	168,6	191,0
9,00	1,75	49,4	55,1	42,00	5,60	172,6	195,6
9,50	1,79	51,0	56,8	43,00	5,73	176,6	200,2
10,00	1,83	52,4	58,5	44,00	5,86	180,7	204,8
10,50	1,88	53,9	60,2	45,00	5,99	184,7	209,4
11,00	1,93	55,4	62,0	46,00	6,11	188,7	214,1
12,00	2,02	58,5	65,6	47,00	6,25	192,8	218,7
13,00	2,12	61,8	69,3	48,00	6,37	196,8	223,3
14,00	2,22	65,1	73,1	49,00	6,50	200,8	227,9
15,00	2,32	68,4	77,0	50,00	6,63	204,8	232,6
16,00	2,43	71,8	81,0	51,00	6,76	208,9	237,2
17,00	2,54	75,4	85,0	52,00	6,88	213,1	241,8
18,00	2,65	79,0	89,2	53,00	7,01	217,2	246,5
19,00	2,76	82,8	93,4	54,00	7,15	221,3	251,1
20,00	2,88	86,7	97,6	55,00	7,27	225,3	255,7
21,00	2,99	90,4	101,9	56,00	7,40	229,4	260,4
22,00	3,10	94,0	106,2	57,00	7,53	233,4	365,0
23,00	3,22	97,8	110,5	58,00	7,67	237,4	269,6
24,00	3,35	101,5	114,9	59,00	7,79	241,4	27,2
25,00	3,46	105,2	119,2	60,00	7,92	245,5	278,0

cSt = Centistoke (mm²/s)
E° = Engler°

R = Redwood
S = Saybolt

Checking the oil

Hydraulic oil life conditions in % based on temperature

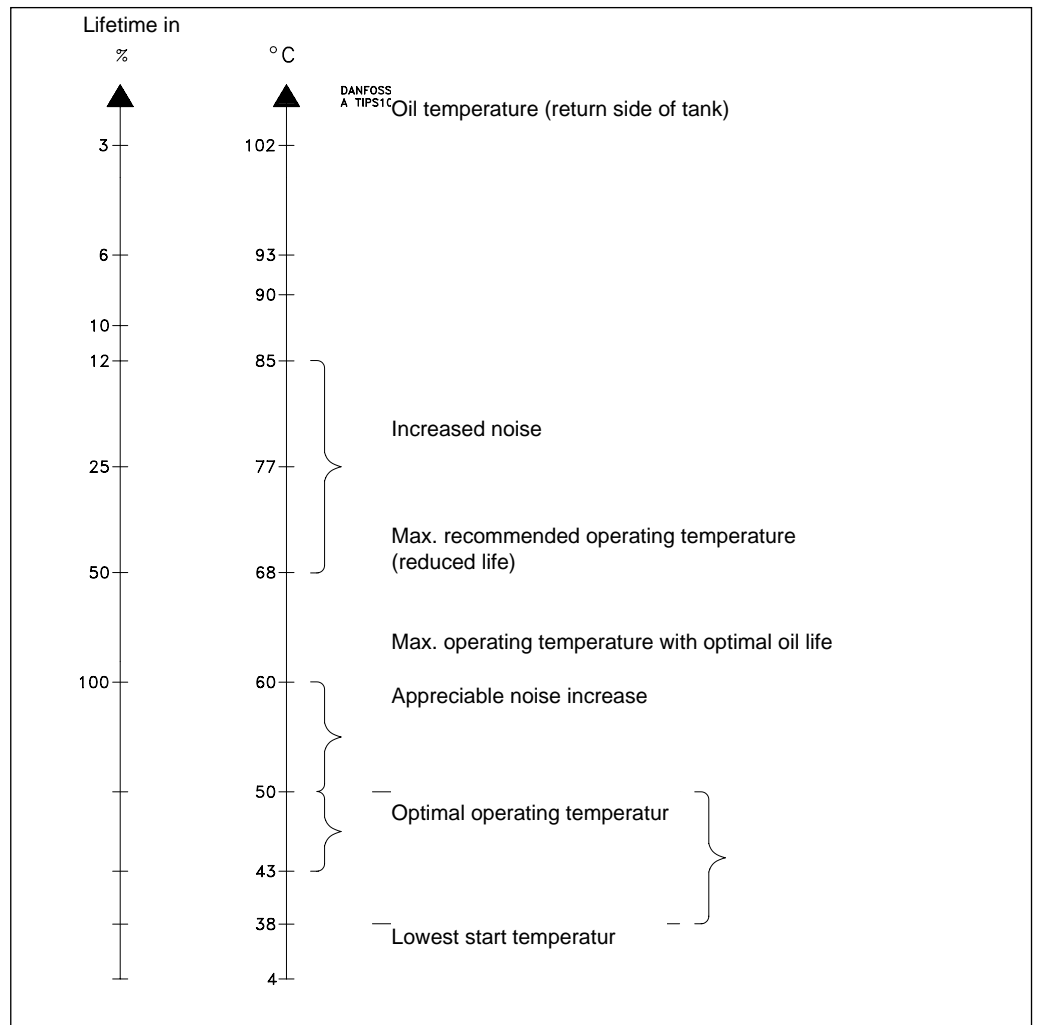

Installation of system

After the designer has made calculations and selected the correct components, a number of questions have to be considered:

Where and how are the components to be placed?

This must be in strict accordance with, amongst others, the following factors:

- Suitability in relation to the work the motor or cylinder must perform.
- Easily accessible for installation and inspection, and not least for repair or replacement. There is no such thing as a system that never needs to be repaired.
- Maximum heat emission is obtained by locating individual components, tanks, pipes, hoses and filters at the outer boundaries of the system. If pipes are bracketed to the machine frame or vehicle chassis, large amounts of heat will be given off.
- Noise suppression is the subject of environment legislation and much can be achieved by installing pumps and their motors on dampers and by using hoses between all moving/vibrating components and rigid parts.

Remember to follow catalogue instructions on pipes, hoses and fittings.

Remember that pipes which are welded or hot-bent must be thoroughly cleaned. Scale etc. must be cleaned by wire brushing or by pickling followed by thorough flushing and drying.

Remember it is very advisable to read the supplier's directions and meet the requirements contained in the installation instructions which nearly always accompany components.

Remember the three most important rules to be followed when working with hydraulics are:

1. CLEANLINESS
2. CLEANLINESS
3. CLEANLINESS

Rule 1

Concerns cleanliness during the installation of the hydraulic system.

Hoses, pipes and fittings are never clean after being worked on and must therefore always be cleaned immediately prior to installation. Pipes, including pipe bends, should preferably be cleaned with a plug of crepe paper or lint-free cloth soaked in paraffin and blown through the pipe with compressed air. This process must be repeated with several plugs until a completely clean plug emerges. If pipes have been hot-bent or welded they must be cleaned by pickling in hydrochloric acid, flushed with cold and then hot water and dried. If the pipes are not to be fitted immediately, they must be lubricated with clean hydraulic oil and plugged, otherwise they will rust. The blanking plugs fitted in all pumps, motors, valves, etc. must not be re-moved until just before the components are installed.

Workshops, work stations, tools and clothing must also be as clean as possible. Then there is smoking! Apart from the fire risk, tobacco ash is harmful, it acts as an abrasive. Smoking should therefore be prohibited.

Installation of system

Fine filtration of the oil via a filling filter unit is strongly recommended. When filling from drums there are nearly always too many particles in the oil, especially in the bottom where there is often a little water too. An example of a portable filling filter unit is shown below. It consists of a $\frac{3}{4}$ hk single phase electric motor driving a low pressure pump of 15-20 l/min capacity. The pump sucks from the oil drum through a pipe that can be screwed into the $\frac{3}{4}$ BSP drum connector. The diagonally cut end of the pipe extends to approx. 4-5 cm above the bottom. Oil is sucked through a 40 μm coarse strainer with magnetic insert and then through a 5 μm fine filter. The fine filter can be equipped with a low pressure switch that stops the pump when the filter is about to become saturated with dirt particles.

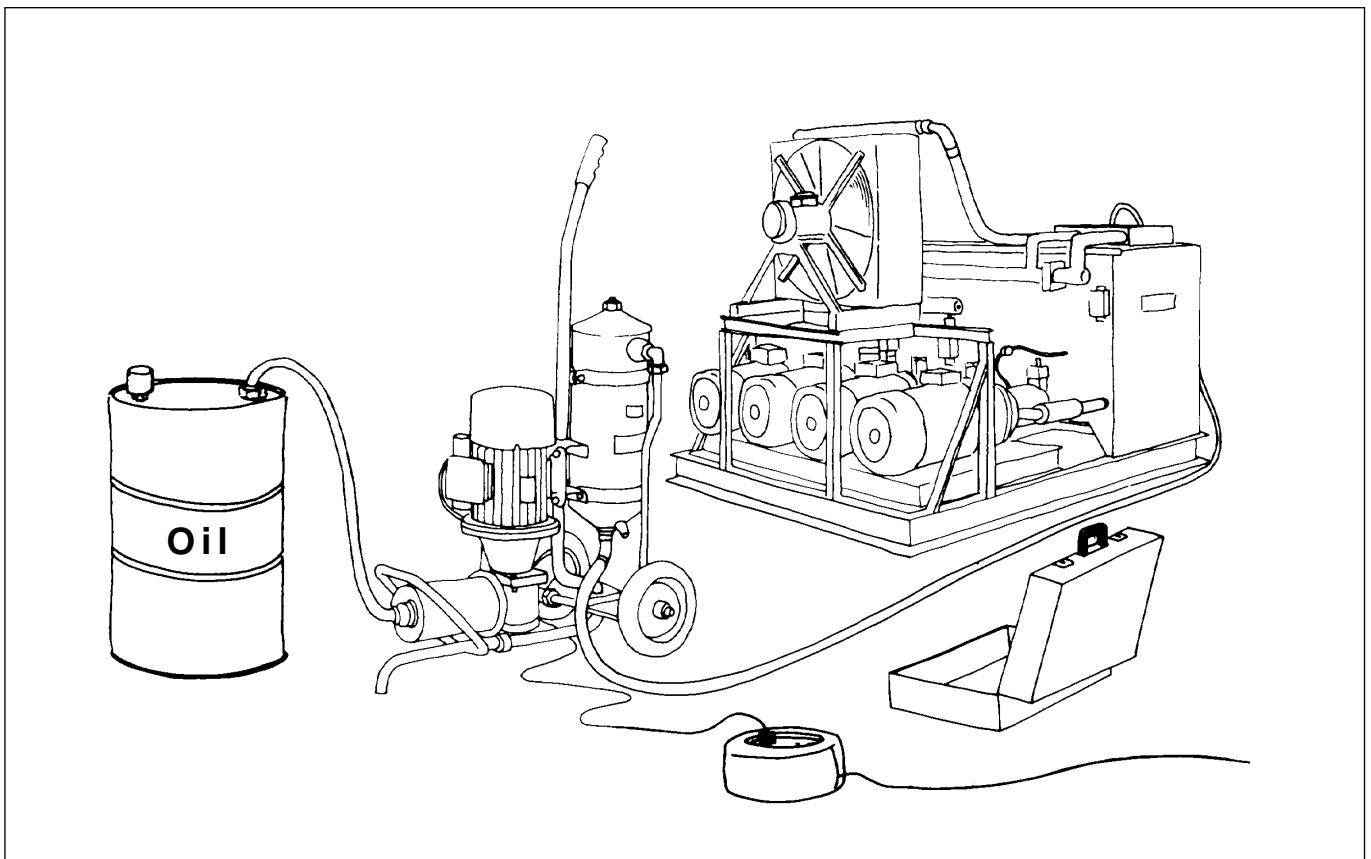
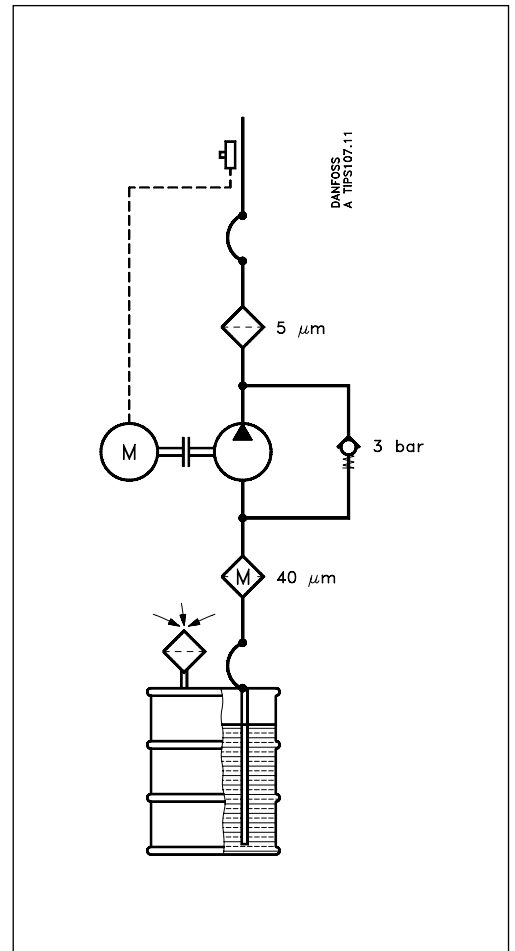

Installation of system

Rule 2 *Concerns cleanliness during daily operation of a hydraulic system.*

Here, the main objective is to prevent the oil from becoming dirty. That is to say, filters (including air filters) must be clean - especially piston rods, shafts and shaft seals. It has been proven that on every square centimetre of piston rod area, one dirt particle of more than 10µm penetrates the cylinder. Imagine a piston rod of \varnothing 50 mm, a length of just 100 mm, and a velocity of 12 m/min. This means about 20.000 particles larger than 10 µm per minute!

The tools used for filling must of course be perfectly clean and the oil filled into the system must be filtered through filters of the same fineness as the finest in the system, normally 5 µm, but in any event no coarser than 10 µm nominal. Oil in large drums is not normally clean enough and, depending on the storage, often contains water. Therefore drums should be laid down during storage, or better still, should stand on a slant if kept outdoors so that water cannot collect around the plugs.

Rule 3 *Concerns cleanliness during inspection and repair.*

Here also it goes without saying that everything should be kept as clean as possible. Before a hydraulic component is removed, both the component itself and the immediate surroundings must be clean. All loose paint scale must be removed before screwed connections are dismantled and all open parts, pipes, hoses, etc. must be blanked off with, for example, plastic bags

bound on so that dirt and dust cannot enter the system when it is in standstill.

A hydraulic component must never be dismantled outdoors, but always in a closed workshop equipped with necessary facilities, special equipment and trained personnel.

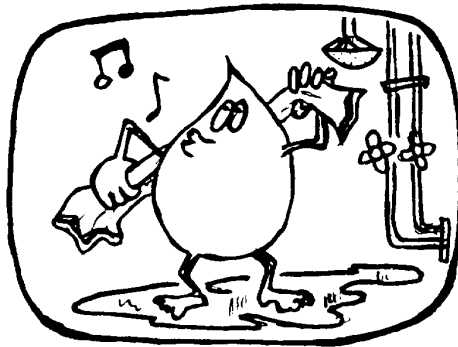

Starting up and running in of plant

Correct starting up and running-in is of the utmost importance in ensuring that the system runs for a long time without problems. All too often, many systems and especially pumps "die" after only a few hours running, some after only a few minutes, because the most elementary steps have been overlooked. One example is the non-observance of the cleanliness rules before and during start-up.

But despite even the best degree of cleanliness and care during installation, the presence of dirt in a new system cannot be avoided. During running-in, wear particles will be produced from all moving parts. It is therefore important not to apply full load to the system before this dirt has been filtered out.

Let us look at our system which is fitted with a Danfoss pump type VPA and study the procedure for starting up:

1. Examine the tank to make sure it is perfectly clean internally. If it is not, clean it out with a vacuum cleaner. Often during installation, it is necessary to bore and tap a few extra holes which are not shown on the drawing.
2. Fill with clean oil of the correct type - through a filtering unit as described on page 23. If such a unit is not available, any filling funnels, cans, hoses must be thoroughly cleaned before they are used. Oil is filled through the return filter.
3. Before the pump is started, check the following:
 - a) Have all the flanges and screwed connections been tightened? (There is always one that hasn't).
 - b) Is the directional valve in its neutral position? (If it is not, the results can be catastrophic).
 - c) Is the pressure relief valve set at minimum? (The result of a leak or a malfunction is more violent at high pressure than at low pressure).
 - d) Does the pump rotate in the correct direction? (Nearly all pumps have a particular direction of rotation: clockwise or counterclockwise looking on the end of the output shaft. The direction ought to be clearly marked with an arrow. Many pumps will not withstand being rotated in the wrong direction for more than a few minutes).
 - e) Is the pump and any suction line filled with oil? (Some pumps cannot withstand being rotated for more than a few minutes without oil in the pump housing).
4. Connect a vacuum meter in the suction line, as close to the pump as possible. Connect a 250 bar pressure gauge to the high pressure side of the system. Connect a 5 bar pressure gauge to the upper drain connection. Pumps with a priming pump must be fitted with a 25 bar pressure gauge on the priming pump take-off. If there is more than one pump on the same shaft, each pump must be fitted with these pressure gauges.
5. If possible, connect the discharge side of the pump to the tank, otherwise to a 5-10 litre container.
6. Set the pump displacement to at least 40% of maximum.
7. Start the pump (with a combustion engine at 800-900 r/min, or with an electric motor having short-duration start/stop functions). When the pump starts to suck (oil runs into the tank or container) stop the pump and connect its pressure outlet to the high pressure side of the system.
8. If the pump does not suck relatively quickly, check the following:
 - a) Is the suction line leaky?
 - b) Is there free flow in the suction line?
 - c) Does the pump rotate at all?
 - d) Is the pump set for min. 40% displacement?
9. Start the pump once more. Operate each directional valve for each motor or cylinder one after another, with a necessary bleeding at as low a pressure as possible. Repeat until the return oil in the tank does not foam and the motors and cylinders operate smoothly. Check the oil level frequently and refill with filtered oil.
10. A further frequent check: make sure that the suction pressure is at least 0.8 bar absolute, corresponding to 0.2 bar on the scale. After a short time, the drain pressure must be max. 1 bar.
11. Set the pump for max. displacement and the motor for max. speed (but not higher than 3150 r/min continuous) and allow the system to run unloaded for about 20 minutes, until the oil temperature has stabilized. Reverse the direction of the motor and the travel of the cylinders frequently.
12. Set the individual pressure relief valves and the pump pressure control valve at the specified pressure. Any shock valves in the system must be set at approx. 30-40 bar over the constant operating pressure. Check the oil temperature.
13. If required, the pump max. oil flow can be set using the flow limiter.

Starting up and running in of plant

14. Remove the pressure gauges and vacuum meter and insert plugs in the connections. Replace filter inserts with new ones. Check the oil level.
15. If there is a large amount of oil (e.g. more than 100 litres in the system), an oil sample can be taken and sent to the oil supply firm for analysis.
16. The system can now be put to work.

Maintenance

Nearly all hydraulic systems, stationary as well as mobile, are accompanied by operating instructions, but the issue of maintenance instructions is just as important. To be able to correctly maintain a hydraulic system, the

customer (end user) must know what has to be done. The transfer of this knowledge is the responsibility of the manufacturer.

Periodic inspection

The regular inspection of a hydraulic system is more economical than making repairs when a fault occurs. If a fault does occur, the whole system ought to be checked rather than just the defective component. Regular planned preventative maintenance of the system after a certain number of operating

hours and the scheduled replacement of important seals ensures the avoidance of costly operational stops.

To avoid forgetting something, a routine following the direction of oil flow should be adopted, beginning with:

The tank

The oil level must be correct and the oil must be of the prescribed type and viscosity. On large systems it pays to send oil samples for analysis at regular intervals. Factors of special importance in deciding whether the oil can continue to be used are the rise in oil viscosity, the acidity number and the content of impurities. If there is no special equipment available,

the oil by looking at its colour. Poor oil can be dark, it can smell rancid or burnt; or it can be yellow, unclear or milky, which indicates the presence of air or emulsified water. And of course the oil might contain free microscopic metal particles and other foreign substances.

The suction line

The suction line must be inspected for damage and sharp bends that reduce the bore of the pipe and create noisy cavitation. Screwed connections must be inspected for leaks and tightened if necessary.

Rubber or plastic hoses are suspect because they often become contracted by vacuum when the oil is hot. Such items should be replaced with pipes or armoured hoses.

The pump

The pump must be inspected for shaft seal and other leakage. If the pump is driven by V-belt, this should be examined to ensure that it is not worn and is correctly tensioned. The different circuits on the pressure side must be examined individually, following the direction of oil flow. There must be no leaks. Look on the floor

under the vehicle for oil patches. The fingertips are good instruments for sensing faults, the ears too - by using a screwdriver or similar tool as a stethoscope, irregularities which might later cause breakdown can often be heard.

The return line and return filter

The return line and return filter must be inspected for leaks, etc. and the filter must be checked. If the filter has a dirt indicator the condition of the filter can easily be seen. If there is no dirt indicator, the filter has to be taken out to see whether it needs cleaning or replacement.

Trouble shooting

Under this heading, it is obvious that the two basic factors, pressure and flow, must be in accordance with specifications. If the opposite is true nothing will function perfectly. If the condition of the pump is suspect, the pressure line from the system must be disconnected and a pressure gauge fitted, together with a throttle valve and flow meter, as shown in the sketch below.

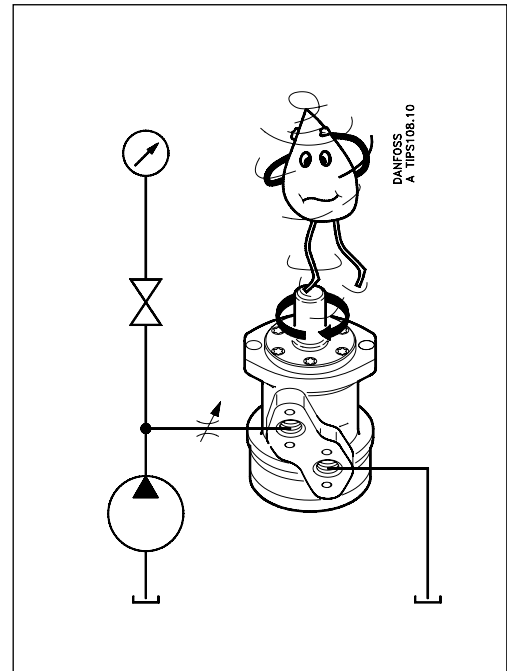

If no flow meter is available, a Danfoss hydraulic motor can be fitted instead. The displacement of the motor per revolution with unloaded shaft is very precise and to find flow all that is necessary is to count the number of revolutions per minute and multiply the figure by the displacement, as shown in the following examples:

Example 1: OMR 100:

$$\frac{\text{Rev./min.} \times 100}{1000} = \text{l/min} \quad \frac{220 \times 100}{1000} = 22 \text{ l/min}$$

Example 2: OMR 315:

$$\frac{\text{Rev./min} \times 315}{1000} = \text{l/min} \quad \frac{116 \times 315}{1000} = 36,5 \text{ l/min}$$

Pump test

Check the flow with completely open throttle valve.

Increase the throttle until it corresponds to normal operating pressure.

Again check the flow and compare it with the values given in the pump catalogue.

The volumetric efficiency of the pump can be calculated thus:

$$\eta_{\text{Vol.}} = \frac{\text{flow with operating pressure}}{\text{flow with no pressure}}$$

If the capacity with operating pressure, and thereby the μ vol. is too low, the pump has internal leakage - as a rule because of wear or seizing.

In the following, fault location is divided into three sections:

- the first section deals with hydraulic systems in general,
- the second with motors,
- and the third with systems that incorporate hydrostatic steering systems.

Trouble shooting general

THINK before starting trouble shooting
Every fault location process should follow a logical and systematic order. Usually it is wisest to start at the beginning:

- Is the oil level correct when the pump is operating?
- Is the condition of oil and filters acceptable?
- Are pressure, flow and flow direction as specified?
- Is the oil temperature too high or too low (oil viscosity)?
- Are there any unrequired vibrations or noise (cavitation)?

If the driver of the vehicle is available ask him:

- what type of fault it is and how it affects the system,
- how long he has felt that something was wrong
- whether he has "fiddled" with the components
- whether he has any hydraulic and electrical diagrams available.

Diagrams are often found in the instructions included with vehicles/machines. Unfortunately they are often so technical that they are not of much use in a fault location situation. However, the order of and the connections between the individual components are often shown.

When a defect component has, with certainty, been found both the component and its surroundings must be cleaned before removal. Loose paint must also be removed from pipes and fittings.

Holes, hoses and pipe ends must be blanked off with plugs or sealed with, for example, plastic bags after removal to avoid the entry of dirt during standstill. Never dismantle hydraulic components outside. We recommend that repairs be carried out in a workshop on a clean workbench perhaps covered with newspaper.

Make sure that a Danfoss service manual dealing with the product in question is handy. Follow the instructions word for word both when dismantling and assembling because if these instructions are not followed closely serious faults may develop. NB. In some cases special tools are necessary for assembling. Our service manuals give full guidance as to when this is the case.

Fault location tips

Fault	Possible cause	Remedy
Pump noisy	<ol style="list-style-type: none"> 1. No or insufficient oil supply to pump. 2. Viscosity of oil too high. 3. Pump takes in air: <ol style="list-style-type: none"> a) at the pump shaft b) at loose or damaged suction line c) oil level too low d) oil takes in air in the tank(return pipe discharging over oil surface) 4. Pump worn out. 5. R.p.m. too high. 6. Oil pressure too high. 	<ol style="list-style-type: none"> 1. Clean suction filter. Check that no damage or narrowing is to be found on suction line. 2. Change the oil, adjust viscosity to working temperature. 3. Replace shaft seal. Tighten fittings or replace suction line. Refill with clean oil. Extend return pipe to 54 cm under the surface and as far as possible from the suction pipe. 4. Repair or replace pump. 5. Adjust the r.p.m. 6. Adjust oil pressure.
No pressure	<ol style="list-style-type: none"> 1. Oil level too low. 2. Pump does not run or runs in the wrong direction. 3. Relief valve is stuck in open pos. 4. Pump defectiv, broken shaft or key for rotor. 	<ol style="list-style-type: none"> 1. Refill with clean oil. 2. Adjust direction of rotation. Check driving belt or coupling. 3. Repair relief valve. 4. Repair pump.
No or unstable pressure	<ol style="list-style-type: none"> 1. Working pressure too low. 2. Leaky pressure adjusting valve or pilot valve. 3. The oil flows more or less to the tank through defectiv valve or cylinder. 	<ol style="list-style-type: none"> 1. Check pressure adjusting valve. 2. Repair valve. 3. Repair cylinder or valve.
Noise in the relief valve	<ol style="list-style-type: none"> 1. Excessive flow. 2. Dirt or chips between valve cone and valve seat. 	<ol style="list-style-type: none"> 1. Fit a larger valve corresponding to the actual oil volume. 2. Repair valve.
Air in the system, foam in the oil	<ol style="list-style-type: none"> 1. Leaky suction line. 2. Excessive resistance in suction line. 3. Return line discharges above the oil level - could cause foam formation. 4. Incorrect oil type. 	<ol style="list-style-type: none"> 1. Retighten or replace line. 2. Clean filter and suction line, or replace with pipes having larger bores. Check fittings. 3. Remove return line from suction line and extend if necessary. 4. Change over to correct oil type.
Overheated system	<ol style="list-style-type: none"> 1. No supply of cooling water. 2. Oil cooler blocked or dirty. 3. Excessive oil viscosity. 4. Abnormal internal leakage in one or more components. 5. Altered running conditions. 6. Pump, valves or motor overloaded. 	<ol style="list-style-type: none"> 1. Re-establish supply of cooling water. 2. Clean oil cooler. 3. Change over to correct oil type. 4. Repair or replace defectiv components. 5. Estabiish extra cooling if necessary. 6. Reduce load or replace component with a bigger one.

Fault location tips

HYDRAULIC MOTORS		
Fault	Possible cause	Remedy
R.p.m. of motor lower than rated value	<ol style="list-style-type: none"> 1. Pump worn out. 2. R.p.m. of pump too low. 3. Motor worn out. 4. Oil temperature too high (resulting in excessive internal leakage in motor, valves etc.) Possibly too high ambient temperature. 5. Insufficient diameter in pipes etc. 6. Pump cavitation. 7. Opening pressure of pressure relief valve too low. 8. Leaky control valve. 9. Overloaded motor. 	<ol style="list-style-type: none"> 1. Repair or replace pump. 2. Adjust the r.p.m. 3. Repair or replace motor. 4. Build in oil cooler or increase existing cooler or tank capacity. If necessary change over to oil with a higher viscosity. 5. Fit lines with larger diameter. 6. (See under: Pump noise). 7. Adjust to correct pressure. 8. Repair valve. 9. Eliminate the cause of the overload or change over to larger motor.
Motor shaft does not rotate	<ol style="list-style-type: none"> 1. Pump does not run or runs in the wrong direction. 2. Motor spool has seized in housing. 3. Cardan shaft or spool broken (shaft and commutator valve in two). 4. Working pressure too low. 5. Sand, steel chips or similar impurities in motor. 	<ol style="list-style-type: none"> 1. Start pump or reverse direction of rotation. 2. Replace complete shaft and housing. 3. Replace cardan shaft or complete shaft and housing. Eliminate external forces which caused the fracture. 4. Adjust opening pressure of relief valve to higher value, however, within permissible limits. If necessary, change over to motor with higher torque. 5. Clean the motor, and flush system thoroughly. Replace defective parts. Use a better filter.
Motor shaft rotates in the wrong direction	<ol style="list-style-type: none"> 1. Oil lines are wrongly connected to motor ports. 2. Gear-wheel and rotary valve incorrectly fitted. 	<ol style="list-style-type: none"> 1. Change the connections. 2. Adjust settings.
Leakage at motor shaft	<ol style="list-style-type: none"> 1. Shaft seal worn out or cut. 	<ol style="list-style-type: none"> 1. Replace shaft seal.
Leak between motor spigot and housing	<ol style="list-style-type: none"> 1. Spigot is loose. 2. O-ring defective. 	<ol style="list-style-type: none"> 1. Tighten screws with prescribed torque. 2. Replace O-ring.
Leaks between housing, spacer plate, gear wheel set and end cover, respectively	<ol style="list-style-type: none"> 1. Screws loose. 2. O-rings defective. 3. Steel washers defective 	<ol style="list-style-type: none"> 1. Tighten screws with prescribed torque. 2. Replace O-rings. 3. Replace steel washers.

Fault location tips

Steering systems with OSPB-OSPC-OVP/OVR- OLS

The following quick methods of testing steering systems can be recommended:

1. Start the motor (pump) and let it run for a couple of minutes.
2. Drive slowly in a figure of eight. Pay special attention to any shaking or vibration in the steering wheel or steered wheels. See whether the steering wheel movements are immediately followed by a corresponding correction of the wheel movements, without any "motoring" tendencies.
3. Stop the vehicle and turn the steering wheel with small quick movements in both directions. Let go of the steering wheel after each movement. The steering wheel must immediately go back to the neutral position i.e. there should be no "motoring" tendencies.
4. While the vehicle is still stationary turn the steering wheel from stop to stop. Count the number of times the steering wheel turns in both directions. Note: It must be possible to turn the steering wheel with one finger.

Stop the motor (pump) and again turn the steering wheel from stop to stop. Again count the number of turns and compare with previous figures. If there is a large difference (1 turn or more) the leakage in the cylinder, gear wheel set, shock valve or suction valve is too large.

With larger vehicles where there is no emergency steering function, turn the steering wheel whilst the motor is idling.
5. If there is a leak, remove a hose from one of the cylinder ends and plug this and the hose. Try to turn the steering wheel again. If the wheel cannot turn the cylinder is defective. If this is not the case the steering unit or valve block is defective.

Fault location tips

Steering units OSPB - OSPC - OVP/OVR - OLS		
Fault	Possible cause	Remedy
Steering wheel is heavy to turn	<ol style="list-style-type: none"> 1) No or insufficient oil pressure <ol style="list-style-type: none"> a) Pump does not run b) Pump defective c) Pump runs in the wrong direction d) Pump is worn out e) Pump is under dimensioned 2) Pressure relief valve is stuck in open position or setting pressure is too low. 3) Priority valve is stuck in open position. 4) Too much friction in the mechanical pans of the vehicle. 5) Emergency steering balls missing. 6) Combination: Downstream system + steering unit with suction valve and differential cylinder are inexpedient. 	<ol style="list-style-type: none"> a. Start up pump (loose V-belt) b. Repair or replace pump c. Correct direction of rotation of pump or replace pump d. Replace pump <ol style="list-style-type: none"> e. Install a larger pump (examine pressure need and flow) 2) Repair or clean pressure relief valve. Adjust the valve to the correct pressure. 3) Repair or clean the priority valve. 4) Lubricate bearings and joints of steering gear or repair if necessary Check steering column installation. 5) Install new balls. 6) Change cylinder type (throughgoing piston rod). If necessary use two differential cylinders.
Regular adjustments of the steering wheel are necessary ("Snake-like driving")	<ol style="list-style-type: none"> 1. Leaf spring without spring force or broken. 2. Spring in double shock valve broken. 3. Gear wheel set worn. 4. Cylinder seized or piston seals worn. 	<ol style="list-style-type: none"> 1. Replace leaf springs. 2. Replace shock valve. 3. Replace gear wheel set. 4. Replace defective parts.
Neutral position of steering wheel cannot be obtained, i.e. there is a tendency towards "motoring"	<ol style="list-style-type: none"> 1. Steering column and steering unit out of line. 2. Too little or no play between steering column and steering unit input shaft. 3. Pinching between inner and outer spools. 	<ol style="list-style-type: none"> 1. Align the steering column with steering unit. 2. Adjust the play and, if necessary, shorten the splines journal. 3. Contact the nearest service shop.
"Motoring" effect. The steering wheel can turn on its own.	<ol style="list-style-type: none"> 1) Leaf springs are stuck or broken and have therefore reduced spring force. 2) Inner and outer spools pinch, possibly due to dirt. 3) Return pressure in connection with the reaction between differential cylinder and steering unit too high. 	<ol style="list-style-type: none"> 1) Replace leaf springs. 2) Clean steering unit or contact the nearest service shop. 3) Reduce return pressure, change cylinder type or use a non-reaction control unit.
Backlash	<ol style="list-style-type: none"> 1) Cardan shaft fork worn or broken. 2) Leaf springs without spring force or broken. 3) Worn splines on the steering column. 	<ol style="list-style-type: none"> 1) Replace cardan shaft. 2) Replace leaf springs. 3) Replace steering column.

Fault location tips

Steering units OSPB - OSPC - OVP/OVR - OLS		
Fault	Possible cause	Remedy
"Shimmy"-effect. The steered wheels vibrate. (Rough tread on tyres gives vibrations)	<ol style="list-style-type: none"> 1) Air in the steering cylinder. 2) Mechanical connections or wheel bearings worn. 	<ol style="list-style-type: none"> 1) Bleed cylinder. Find and remove the reason for air collection. 2) Replace worn parts.
Steering wheel can be turned the whole time without the steered wheels moving.	<ol style="list-style-type: none"> 1) Oil is needed in the tank. 2) Steering cylinder worn. 3) Gear wheel set worn. 4) Spacer across cardan shaft forgotten. 	<ol style="list-style-type: none"> 1) Fill with clean oil and bleed the system. 2) Replace or repair cylinder. 3) Replace gear wheel set. 4) Install spacer.
Steering wheel can be turned slowly in one or both directions without the steered wheels turning.	<ol style="list-style-type: none"> 1) One or both anti-cavitation valves are leaky or are missing in OSPC or OVP/OVR. 2) One or both shock valves are leaky or are missing in OSPC or OVP/OVR 	<ol style="list-style-type: none"> 1) Clean or replace defect or missing valves. 2) Clean or replace defective or missing valves.
Steering is too slow and heavy when trying to turn quickly	<ol style="list-style-type: none"> 1) Insufficient oil supply to steering unit, pump defective or number of revolutions too low. 2) Relief valve setting too low. 3) Relief valve sticking owing to dirt. 4) Spool in priority valve sticking owing to dirt. 5) Too weak spring in priority valve. 	<ol style="list-style-type: none"> 1) Replace pump or increase number of revolutions. 2) Adjust valve to correct setting. 3) Clean the valve. 4) Clean the valve, check that spool moves easily without spring. 5) Replace spring by a stronger (There are 3 sizes: 4, 7 and 10 bar).
"Kick-back" in steering wheel from system. Kicks from wheels.	<ol style="list-style-type: none"> 1) Fault in the system. 	<ol style="list-style-type: none"> 1) Contact vehicle supplier or Danfoss.
Heavy kick-back in steering wheel in both directions.	<ol style="list-style-type: none"> 1) Wrong setting of cardan shaft and gear wheel set. 	<ol style="list-style-type: none"> 1) Correct setting as shown in Service Manual.
Turning the steering wheel activates the steered wheels opposite.	<ol style="list-style-type: none"> 1) Hydraulic hoses for the steering cylinders have been switched around. 	<ol style="list-style-type: none"> 1) Reverse the hoses.
Hard point when starting to turn the steering wheel.	<ol style="list-style-type: none"> 1) Spring force in priority valve too weak. 2) Air in LS and /or PP pipes. 3) Clogged orifices in LS or PP side in priority valve. 4) Oil is too thick (cold). 	<ol style="list-style-type: none"> 1) Replace spring by a stronger (4, 7 and 10 bar). 2) Bleed LS and PP pipes. 3) Clean orifices in spool and in connecting plugs for LS and PP. 4) Let motor run until oil is warm.
Too little steering force (possibly to one side only).	<ol style="list-style-type: none"> 1) Pump pressure too low. 2) Too little steering cylinder. 3) Piston rod area of the differential cylinder too large compared with piston diameter. 	<ol style="list-style-type: none"> 1) Correct pump pressure. 2) Fit a larger cylinder. 3) Fit cylinder with thinner piston rod or 2 differential cylinders.

Fault location tips

Steering units OSPB - OSPC - OVP/OVR - OLS		
Fault	Possible cause	Remedy
Leakage at either input shaft, end cover, gear-wheel set, housing or top part.	<ol style="list-style-type: none">1) Shaft defective2) Screws loose.3) Washers or O-rings defective.	<ol style="list-style-type: none">1) Replace shaft seal, see Service Manual2) Tighten screws Torque 3-3,5 daNm OR steering unit (2,5-3 daNm).3) Replace washers and O-rings.

Fault location tips

Steering systems with OSQA/B og OSPBX-LS		
Fault	Possible cause	Remedy
Amplification too large	<ol style="list-style-type: none"> 1) Dirty, leaky or missing check valve(1). 2) Piston (2) sticks in the open position. 	<ol style="list-style-type: none"> 1) Clean or replace check valve. 2) Clean and check that the piston moves easily.
Amplification too small	<ol style="list-style-type: none"> 1) Piston (2) sticks in the closed position. 2) Piston (2) incorrectly installed (only OSQA/B-5). 	<ol style="list-style-type: none"> 1) Clean and check that the piston moves easily. 2) Rotate the piston 180° on its axis.
Heavy turning of steering wheel and slow increase of amplification	<ol style="list-style-type: none"> 1) Dirty orifices (3) in directional valve. 2) Dirty orifice (4) in the combi-valve spool. 3) Dirty orifice (5) in housing. 4) Dirty orifice (6) in LS-port. 5) Dirty orifice in throttle/check valve (7) in PP-port. 	<ol style="list-style-type: none"> 1) Clean or replace orifice. 2) Clean or replace orifice. 3) Clean or replace orifice. 4) Clean or replace orifice. 5) Clean or replace throttle/check valve.
No end stop in one or both directions	<ol style="list-style-type: none"> 1) One or both shock valves (8) set too low. 2) One or both anti-cavitation valves (9) leaky, or stickins. 3) Missing end-stop plate (s) (pos. 10) for directional valve. 	<ol style="list-style-type: none"> 1) Setting takes a long time without special equipment. Contact the nearest serviceshop. 2) Clean or replace completely shock/anti-cavitation valve (s). 3) Fit end-stop plates .
"Hard" point when starting to turn the steering wheel.	<ol style="list-style-type: none"> 1) Air in LS and/or PP pipes. 2) Spring force in the built in priority valve too weak (11). 3) Orifices in respectively LS-(6) or PP-(7) ports blocked. 	<ol style="list-style-type: none"> 1) Bleed pipes. 2) Replace spring by one which is more powerful. (There are three sizes: 4, 7 and 10 bar). 3) Take out and clean orifices.
No pressure build-up	<ol style="list-style-type: none"> 1) LS-pressure limitation valve (12) adjusted too low. 2) Spool and sleeve in OSPBX steering unit put together incorrectly. 3) Emergency control ball in steering unit missing. 4) Pump does not run or is defective. 	<ol style="list-style-type: none"> 1) Remove plug and set to specified pressure. 2) Take out spool set and turn the inner spool 180° in the outer sleeve. (See Service Manual). 3) Install new ball. 4) Repair or replace pump.

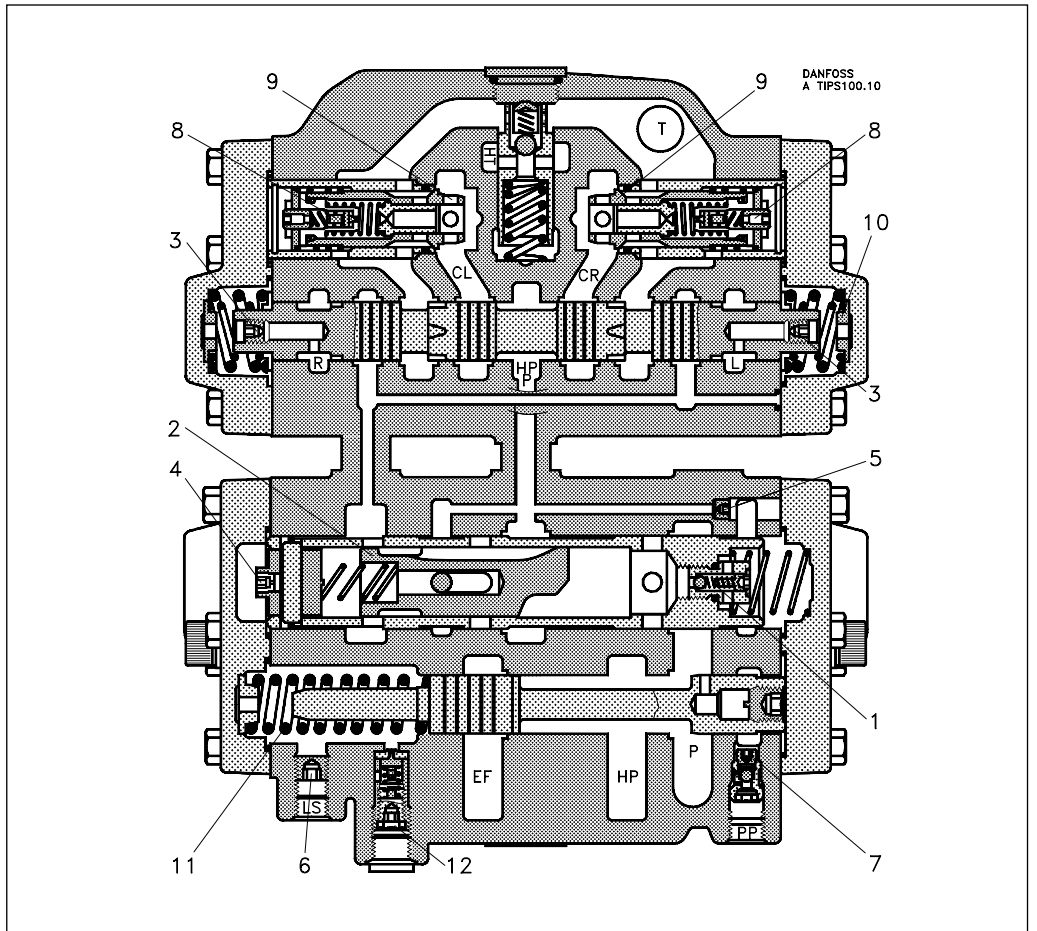
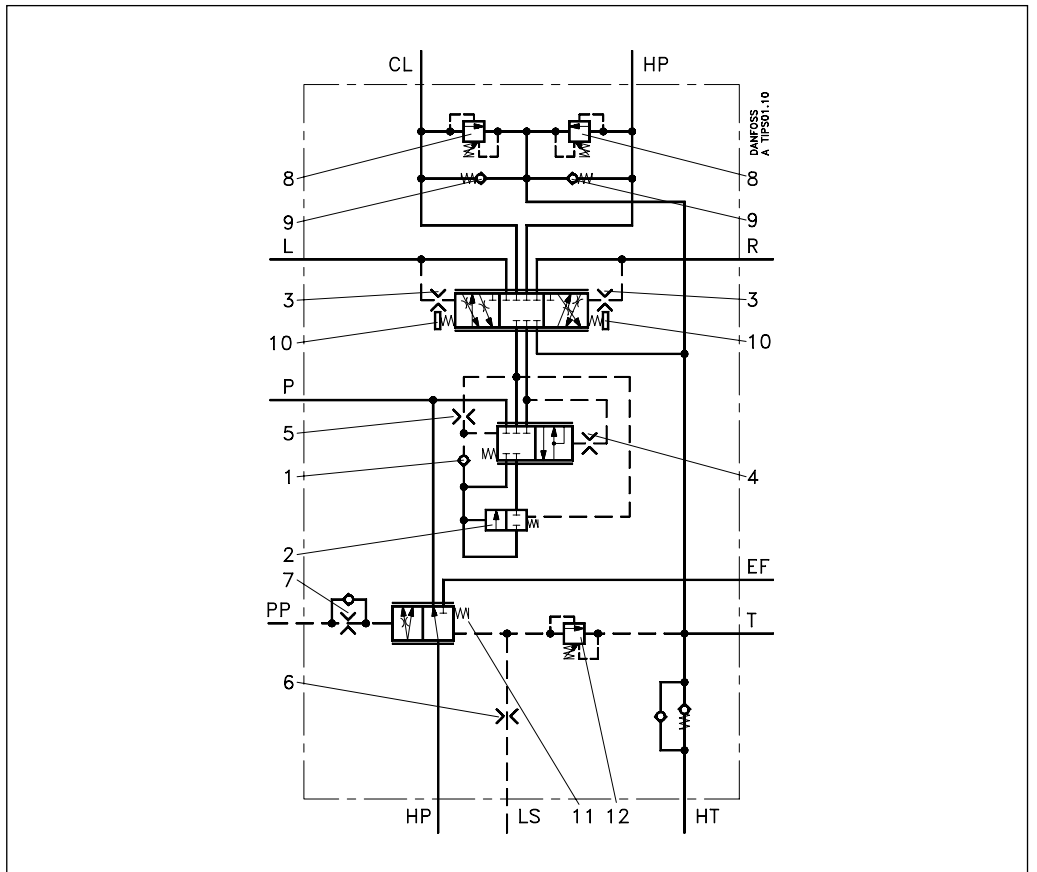

Repair and testing

Repair

After fault location has revealed which system component is defective, that component must be removed and possibly replaced as a new or repaired one. Before removal, both the component and its surroundings must be cleaned and hoses or pipe ends blanked off with plugs or sealed with plastic bags, etc. to avoid the entry of dirt during standstill. The decision now to be made is whether the component is to be repaired domestically or by the producer. If the concerned component is from Danfoss, we recommend that it be repaired in one of our many service workshops (see list on back page). This particularly applies to more complicated components like steering units, flow amplifiers, pumps and proportional valves. For safety reasons, these all need testing with special equipment after repair.

Of course situations can occur where components require immediate repair. We recommend most strongly that in such circumstances repairs be carried out only in very clean surroundings, in suitable premises on a tidy workbench perhaps covered with newspaper.

Important!

Dismantling and assembly must only be performed if the repairer has the associated Danfoss service manuals. If these are not followed, serious faults might develop;

faults that could give rise to accidents. This is more than likely with steering components and proportional valves.

Testing

In general, all hydraulic components that have been dismantled ought to be tested on a suitable test panel to reveal possible assembly errors. If this is impossible, testing must be performed on the system.

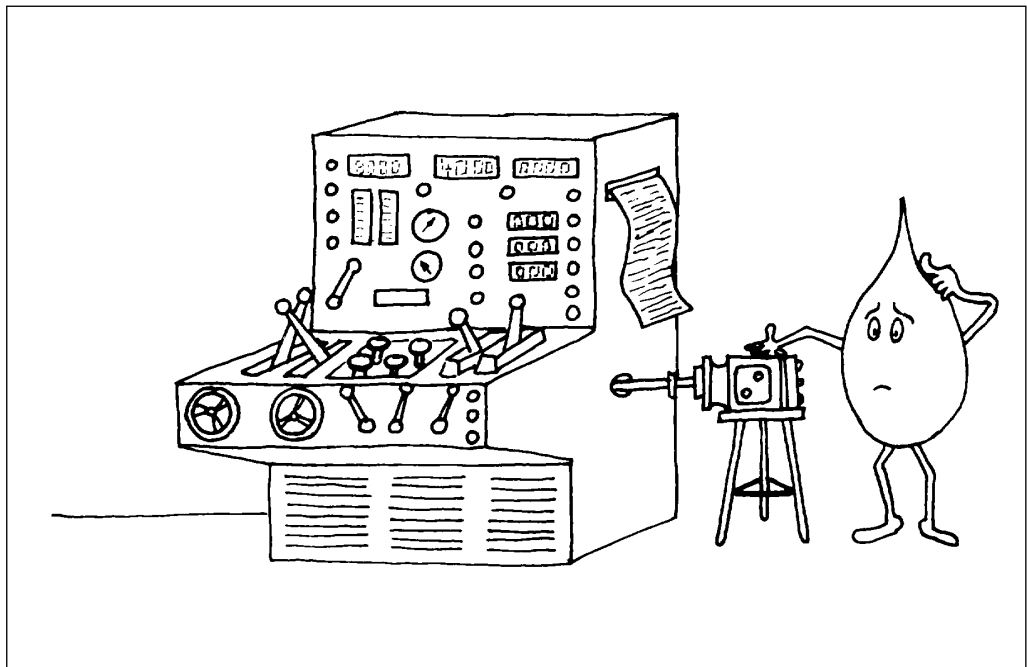

Symbols and Tables

q	= Displacement	: cm ³
n	= Revolutions	: min ⁻¹
p	= Pressure	: bar
Δp	= Pressure drop	: bar
Q	= Oil capacity	: l/min = dm ³ /min
v	= Speed	: m/s
L	= Length	: m
D	= Piston diameter	: mm
d	= Piston rod diameter	: mm
D _i	= Bore of pipe	: mm
D _h	= Hydraulic diameter	: mm
A	= Area	: cm ²
a	= Ring area	: cm ²
t	= Time	: s.
m	= Volume	: kg
F	= Force	: daN
M	= Torque	: Nm
P	= Power	: kW
A _s	= Break load	: daN
E	= Elasticity module	: kp/cm ²
l	= Free column length	: m
S	= Safety factor	
ν	= Kinematic viscosity	: mm ² /s
η _v	= Volumetric efficiency	
η _m	= Mechanical efficiency	
η _t	= Total efficiency	
λ	= Resistance figure	
V _{ac}	= Accumulator size	
V _x	= Required oil capacity available in accumulator	
P ₁	= Lowest oil pressure	
P ₂	= Highest oil pressure	
P ₀	= Pre-charge	

Ratio factors:

Power	1 kw	= 1,36Hp
	1Hp	= 0,736 kw
Torque	1 kpm	= 9,81 Nm
		= 7,233 lbf ft
Pressure	1 Nm	= 0,102 kpm
	1 kp/cm ²	= 98.000 Pa
		= 0,981 bar
		= 9,81 N/cm ²
		= 14,22 psi
	1 psi	= 0,06895 bar
		= 0,0703 kp/cm ²
Volume	1 bar	= 1,0194 kp/cm ²
	1 US, gallon	= 3,785 liter
	1 Eng. gallon	= 4,546 liter
	1 in ³	= 16,38 cm ³
	1 liter	= 1,0 dm ³
Area	1 in ²	= 645,2 mm ²
	1 foot ²	= 92900 mm ²
Speed	1 km/h	= 0,2778 m/s
	1 foot/s	= 0,3048 m/s
	1 mile/h	= 0,447 m/s
Acceleration	1 foot/s ²	= 0,3048 m/s ²
Length	1 in	= 25,4 mm
	1 foot	= 0,3048 m
	1 yd	= 0,9144 m

Pump:

Power consumption $N_{an} = \frac{Q \times p}{600 \times \eta_t}$ [kW]

Supplied oil capacity $Q = \frac{q \times n \times \eta_v}{1000}$ [l/min]

Input torque $M = \frac{q \times p}{62,8 \times \eta_m}$ [Nm]

Motor:

Oil consumption $Q = \frac{q \times n}{1000 \times \eta_v}$ [l/min]

Output torque $M = \frac{q \times \Delta p \times \eta_m}{62,8}$ [Nm]

Output power $N = \frac{Q \times \Delta p \times \eta_t}{600}$ [kW]

Speed $n = \frac{Q \times \eta_v \times 1000}{q}$ [min⁻¹]

Cylinder:

Compressive force $F = p \times A \times \eta_m$ [daN]

Tensile force $F = p \times a \times \eta_m$ [daN]

Speed out $v = \frac{Q \times \eta_v}{6 \times A}$ [m/s]

Speed in $v = \frac{Q \times \eta_v}{6 \times a}$ [m/s]

Oil consumption out $Q = \frac{A \times v \times 6}{2v}$ [l/min]

Oil consumption in $Q = \frac{a \times v \times 6}{2v}$ [l/min]

Compressive force with differential cut-in $F = P \times (A - a) \times \eta_m$ [daN]

Tube:

Flow speed $v = \frac{Q \times 100}{6 \times D^2 \times 0,785}$ [m/s]

Pressure loads in straight pipe leads $\Delta p = \frac{\lambda \times L \times 0,89 \times v^2 \times 5}{D_i}$ [bar]

Resistance number: $\lambda = \frac{64}{Re} \lambda_{turb.} = \frac{0,316}{4\sqrt{Re}}$

Reynolds number $Re = \frac{v \times D_h \times 1000}{\nu}$















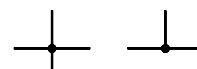

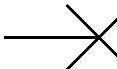

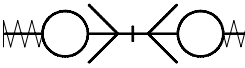

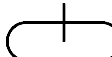

Accumulator size:

With slow charging and slow discharging $V_{ac} = \frac{V_x \times \frac{P_1}{P_0}}{1 - \frac{P_1}{P_2}}$







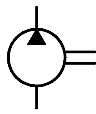
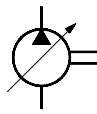
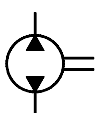
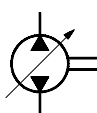
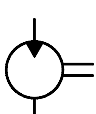
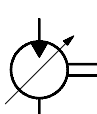
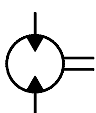
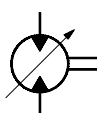

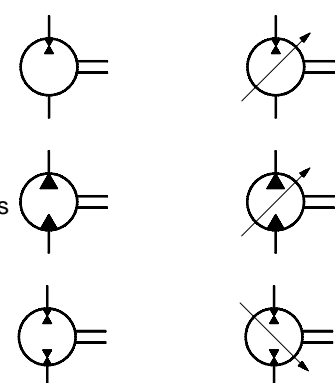
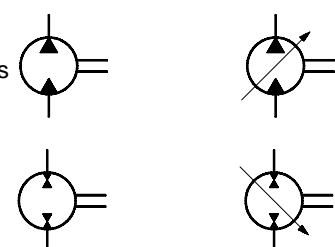
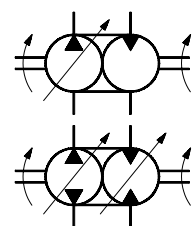
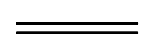
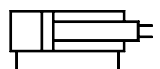

With quick charging and quick discharging $V_{ac} = \frac{V_x \times \frac{P_1}{P_0}}{1 - \frac{P_1}{P_2} \cdot \frac{1}{1,5}}$

With slow charging and quick discharging $V_{ac} = \frac{V_x \times \frac{P_2}{P_0}}{\frac{P_2}{P_1} \cdot \frac{1}{1,5} - 1}$

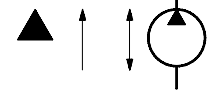

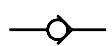

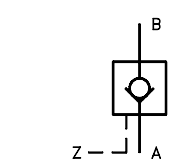
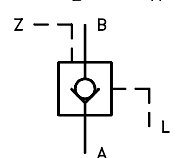
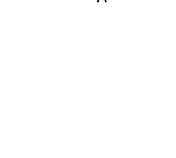
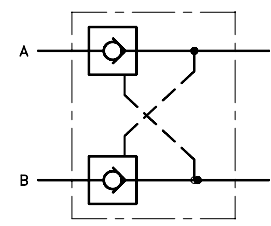
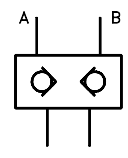
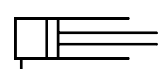

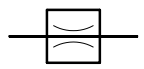
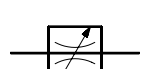
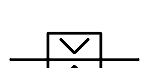
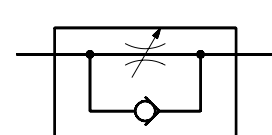
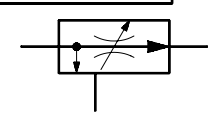
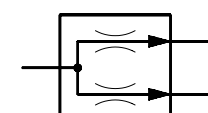

ISO/CETOP Symbols

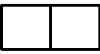
<p>Work line </p> <p>Pilot line </p> <p>Drain line </p> <p>Electric line </p> <p>Flexible line </p> <p>Line connections </p> <p>Crossing lines </p> <p>Venting </p> <p>Pressure connection w. plug </p> <p>With line connection </p> <p>Quick coupling w. check valve </p>	<p>Reservoir, open </p> <p>Reservoir, pressurized </p> <p>Enclosure for several components in one unit </p> <p>Manometer, Thermometer </p> <p>Flow meter </p> <p>Pressure source </p> <p>Electromotor </p> <p>Combustion engine </p> <p>Coupling </p>
<p>Accumulator </p> <p>Filter </p> <p>Cooler </p> <p>Heater </p>	<p>1 Flow direction   Constant Variable</p> <p>2 Flow directions   Displacement pump</p> <p>1 Flow direction   Constant Variable</p> <p>2 Flow directions   Displacement motor</p>

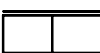
ISO/CETOP Symbols

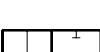
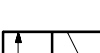
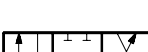
<p>Constant Variable</p>  <p>Combined pump-motors</p>  <p>Hydrostatic transmission</p>  <p>Shaft, lever, rod, piston</p> 	<p>Differential cylinder</p>  <p>Cylinder with cushion</p> 
<p>Spring</p>  <p>Throttling, depending on viscosity</p>  <p>Restriction, not viscosity influenced</p>  <p>Flow direction</p>  <p>Direction of rotation</p>  <p>Variable setting</p> 	<p>Check valve, not spring loaded</p>  <p>Spring loaded</p>  <p>Pilot controlled check valve</p>  <p>Pilot controlled opening</p>  <p>Pilot controlled closing</p>  <p>Example</p>  <p>Simplified</p> 
<p>Cylinders</p> <p>Single acting</p>  <p>Double acting</p> 	<p>Restrictor, fixed</p>  <p>Restrictor, variable</p>  <p>Restrictor, not viscosity influenced</p>  <p>Throttle-check valve</p>  <p>3-way by-pass flow regulator</p>  <p>Flow divider</p> 

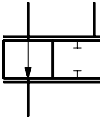
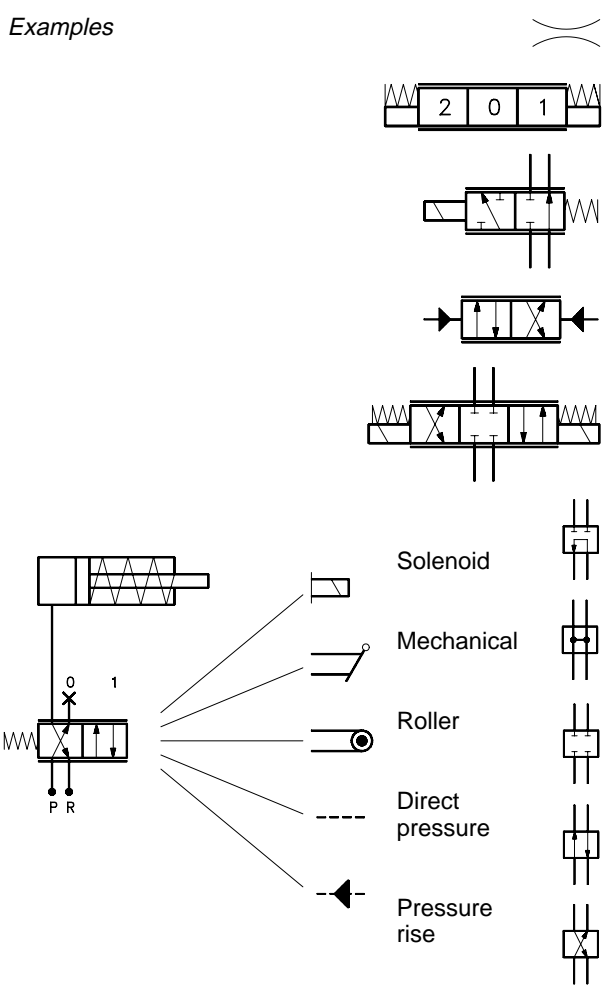
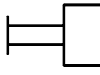
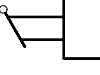
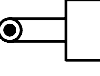
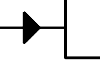
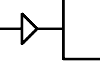
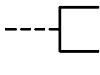
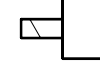
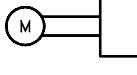
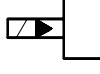
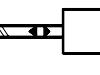
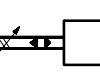
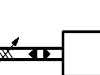
ISO/CETOP Symbols

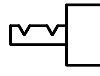
<p>Directional valves</p> <p><i>Basic symbol:</i></p> <p>Two - way </p> <p>Three - way </p> <p>Two - way </p> <p>Without fixed position 2 - extreme position </p> <p>2 - extreme position and between (OSP) </p> <p>2/2 - valve </p> <p>3/2 - valve </p> <p>4/3 - valve </p>	<p>with transient intermitten pos. </p> <p>mechanical feed back </p>
<p><i>Examples</i></p> 	<p>Hand operated </p> <p>Lever </p> <p>Roller </p> <p>Hydraulic operated </p> <p>Pneumatic operated </p> <p>Direkt pressure </p> <p>Solenoid </p> <p>Motor operated </p> <p>Solenoid, hydraulik-operated </p> <p>PVEO </p> <p>PVEM </p> <p>PVEH </p> <p>Pneumatic, hydraulic-operated </p> <p>Mekanical lock </p> <p>Spring return </p>

ISO/CETOP Symbols

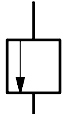
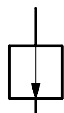
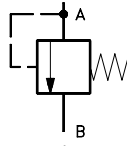
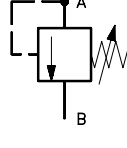
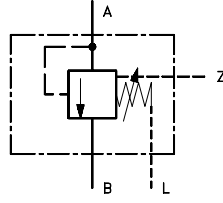
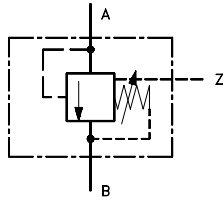
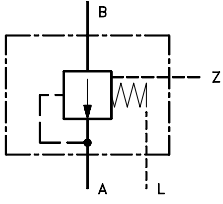
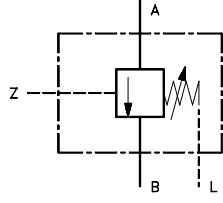
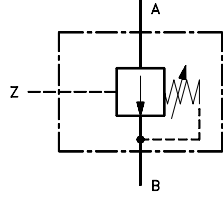
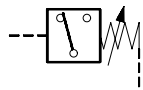
Normally closed		A.B. Work lines
Normally open		P. Pump connection (pressure)
Pressure limiting valve, fixed setting		R.S.T. Return /Tank
Pressure limiting valve, variable		X.Y .Z. Pilot line
Pilot operated, external drain line		L, Drain line
Internal drain		
Pressure reduction line		
Pilot controlled opening valve		
Pilot controlled closing valve		
Pressure switch		

Catalogues or leaflets available for the following hydraulic components

- Low speed hydraulic motors
- Planetary gears
- Hydrostatic steering units
- Steering columns
- Valve blocks
- Flowamplifiers
- Priority valves
- Torque amplifiers
- Variable radial piston pumps
- Pump controls
- Gear wheel pumps for radial piston pumps
- Proportional valves
- Remote control units
- Electronics

Please contact the Danfoss Hydraulics sales organization for further information.

Authorized Service Shops

Australia	: Danfoss (Australia) Pty. Ltd., Melbourne
Austria	: Hainzl Industriesysteme, GmbH., Linz
Belgium	: N.V. Danfoss S.A., Bruxelles
Brazil	: Danfoss do Brasil Ind.e Com. Ltda., São Paulo
Canada	: Danfoss Mfg. Ltd., Mississauga
Denmark	: Danfoss Hydraulik A/S, Ganløse
Finland	: OY Danfoss AB, Espoo
France	: Danfoss S.a.r.l., Trappes (Paris)
Germany	: Danfoss GmbH., Offenbach/Main
Great Britain	: Danfoss Limited, Greenford (London)
Iceland	: Hedinn Verslun HF, Reykjavik
India	: Dantal Hydraulics PVT Ltd., New Delhi
Italy	: Danfoss s.r.l. Division Sordella, Torino
Japan	: Danfoss K.K., Gotemba
Korea	: Unitek Corporation, Seoul
Netherlands	: Itho B.V., Schiedam
New Zealand	: Danfoss (New Zealand) Limited, Auckland
Norway	: Danfoss A/S, Skui
Republic of South Africa	: Danfoss (Pty) Ltd., Johannesburg
Singapore	: Danfoss Industries Pte. Ltd., Singapore
Spain	: Danfoss S.A., San Sebastian de los Reyes, (Madrid)
Sweden	: Danfoss AB, Mjölby
Switzerland	: Danfoss Werner Kuster AG, Frenkendorf
Turkey	: Mert Teknik A.S., Istanbul
U.S.A.	: Danfoss Fluid Power Div. Racine, Wisconsin

Service Shops

Australia	: Danfoss (Australia) Pty. Ltd., Adelaide
Australia	: Danfoss (Australia) Pty. Ltd., Brisbane
Australia	: Danfoss (Australia) Pty. Ltd., Perth
Australia	: Danfoss (Australia) Pty. Ltd., Sydney
Czech Rep.	: Techno Trade, Olomouc
Greece	: A. Skoura & Co. E.E., Athens
New Zealand	: Danfoss (New Zealand) Limited, Christchurch
Taiwan	: Symbridge Machinery Co. Ltd., Taipei

Danfoss can accept no responsibility for possible errors in catalogues, brochures and other printed material. Danfoss reserves the right to alter its products without notice. This also applies to products already on order provided that such alterations can be made without subsequential changes being necessary in specifications already agreed. All trademarks in this material are property of the respective companies. Danfoss and the Danfoss logotype are trademarks of Danfoss A/S. All rights reserved.
